

INSTRUCTION MANUAL

No. EB 2300

for

F.M./A.M. Modulation Meter
TF 2300

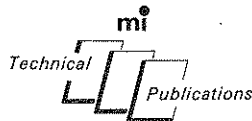

©

1966

MARCONI INSTRUMENTS LIMITED
ST. ALBANS HERTFORDSHIRE ENGLAND

G. L. 5c
3/69/F

EB 2300
1d - 3/69



Contents

Section 1 GENERAL INFORMATION

1.1	Introduction	3
1.2	Data summary	4
1.3	Accessories	6

Section 2 OPERATION

2.1	Installation	7
2.2	Power supply	7
2.3	Controls	8
2.4	Preparation for use	10
2.5	Measuring f. m. deviation	10
2.6	Measuring a. m. depth	11
2.7	Measuring f. m. on a. m.	11
2.8	Measuring a. m. on f. m.	12
2.9	Noise measurements	12
2.10	Oscillator arrangements	14
2.11	Measurement in 1 to 2 Mc/s range	15
2.12	Asymmetric modulation and carrier shift	15
2.13	Use of l. f. output terminals	16
2.14	Use of i. f. output socket	16
2.15	Crystal selection	16
2.16	F. M. stereo measurements	17
2.17	Phase modulation and telemetry deviation	20
2.18	Stray fields	20

Decibel conversion table	21
---------------------------------	-----	-----	-----	----

Section 3 TECHNICAL DESCRIPTION

3.1	System operation	23
3.2	Power unit	24
3.3	Mixer	25
3.4	Local oscillator	25
3.5	I. F. amplifier	26
3.6	Limiter	26
3.7	Discriminator	26
3.8	Calibrator	26
3.9	Low-pass filters	27
3.10	1st l. f. amplifier	27
3.11	2nd l. f. amplifier	27
3.12	Peak reading meter	28
3.13	A. M. detector	28
3.14	Between-units circuitry on chassis	28

Section 4 MAINTENANCE

4.1	Introduction	29
4.2	Access and layout	29
4.3	Performance checks	29

Component layout illustrations	30
---------------------------------------	-----	-----	-----	----

4.4	Cleaning and lubricating	36
-----	--------------------------	-----	-----	----

Section 5 REPAIR

5.1	Introduction	38
5.2	Fault location	38
5.3	Waveforms	39
5.4	Realignment	39
5.5	Replacement of sub-assemblies	45
5.6	Replacement of components	46

Section 6 REPLACEABLE PARTS

Introduction	47
--------------	-----	-----	-----	----

Section 7 CIRCUIT DIAGRAMS

Circuit notes	60
---------------	-----	-----	-----	----

Fig. 7.1	Inter-unit wiring	61
----------	-------------------	-----	-----	----

Fig. 7.2	Mixer, oscillator and i. f. amplifier	63
----------	---------------------------------------	-----	-----	----

Fig. 7.3	Limiter, discriminator and 1st l. f. amplifier	65
----------	--	-----	-----	----

Fig. 7.4	2nd l. f. amplifier and voltmeter	67
----------	-----------------------------------	-----	-----	----

Fig. 7.5	A. M. detector and calibrator	69
----------	-------------------------------	-----	-----	----

Fig. 7.6	Power supply unit	71
----------	-------------------	-----	-----	----

1.1 INTRODUCTION

The TF 2300 Modulation Meter is primarily for measurement of f.m. deviation but it also measures a.m. depth. With its wide range of deviation frequency, modulation bandwidth and carrier frequency, this instrument is suitable for application to fixed and mobile point-to-point communications, broadcasting, telemetry and multi-channel link equipment in the h. f., v. h. f. and u. h. f. bands. Distortion and channel separation tests on f. m. stereo receivers and transmitters can also be made.

Positive and negative f. m. deviation can be measured in ranges from 5 kc/s to 500 kc/s full-scale at modulation frequencies between 30 c/s and 150 kc/s. A. M. depth can be measured up to 95% in a 30 c/s to 15 kc/s modulation bandwidth. Either f. m. or a. m. can be measured in

the presence of the other. Although measurements are normally made by means of the meter readout, i. f. and demodulated outputs are available at the front panel for examination or analysis.

Spurious a. m. and f. m. due to hum and noise are kept to a level insignificant for most applications but, where required, crystals can be switched in to control the local oscillator, or an external local oscillator may be used. The instrument can be operated without a local oscillator for measurements in the 1-2 Mc/s range.

The instrument can be operated from mains power or a nominal 24 V battery. Voltage regulation eliminates transformer tap changing except between 115 V and 230 V ranges. On battery, the regulation compensates for battery voltage variations between 21.5 and 30 V. Transistorized circuits consuming little current give reasonable length of operation on battery for mobile purposes.

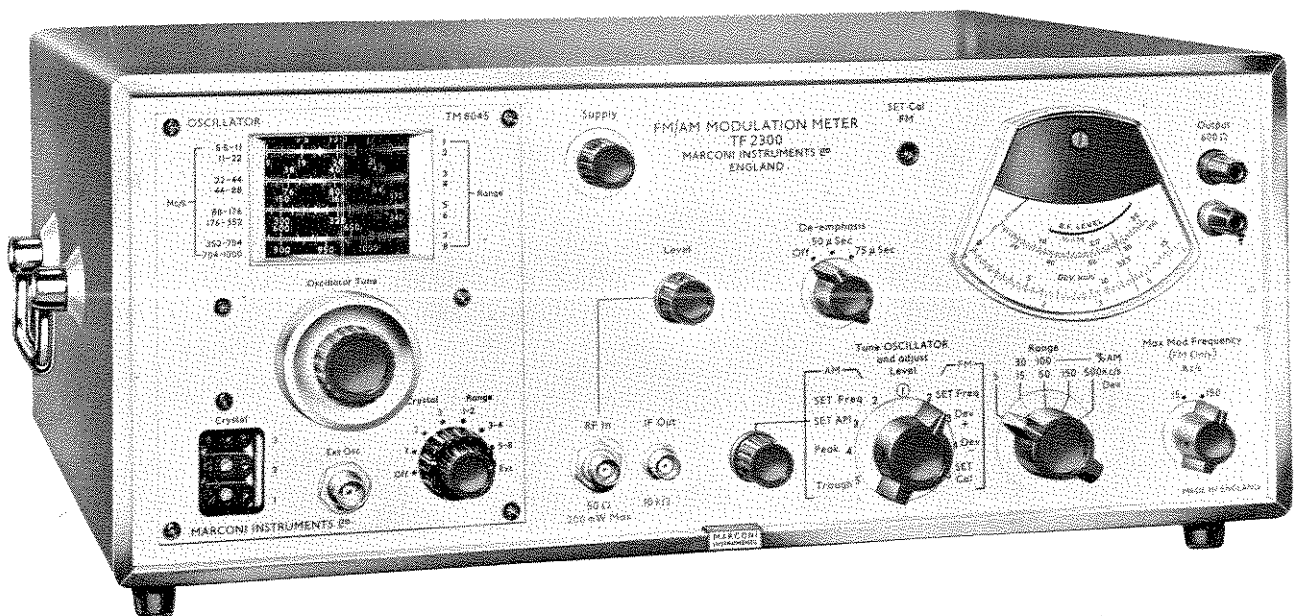

Fig. 1.1 F.M./A.M. Modulation Meter type TF 2300

1.2 DATA SUMMARY

F.M. measurement

Carrier frequency range :	4 to 1000 Mc/s.
Deviation range :	Five ranges with full-scale indications of 5, 15, 50, 150 and 500 kc/s. Positive or negative deviation indication selected by a switch.
Accuracy :	$\pm 3\%$ of full-scale for deviations up to 150 kc/s and modulating frequencies between 30 c/s and 15 kc/s. $\pm 5\%$ of full-scale for deviations up to 500 kc/s and modulating frequencies between 30 c/s and 150 kc/s.
A. M. rejection :	Additional deviation error less than 1 kc/s in 15 kc/s bandwidth when the a. m. depth is 80% and the modulating frequency is 1 kc/s.
Inherent noise :	Deviation less than -70 dB relative to the level of 50 kc/s deviation in a 15 kc/s bandwidth when the local oscillator is crystal controlled.

A.M. measurement

Carrier frequency range :	4 to 350 Mc/s.
Mod. depth range :	Two ranges with full-scale indications of 30% and 100% (maximum usable reading: 95%). Peak and trough indications selected by a switch.
Accuracy :	$\pm 5\%$ of full-scale for modulating frequencies between 30 c/s and 15 kc/s.

R.F. input

Sensitivity :	Less than 20 mV between 4 and 250 Mc/s, less than 50 mV between 250 and 500 Mc/s, less than 100 mV between 500 and 1000 Mc/s.
Maximum input :	<u>3 V r. m. s. (200 mW).</u>
Input impedance :	Nominally 50 Ω .

Local oscillator

Variable frequency operation : The internal oscillator covers two ranges: 5.5 to 11 Mc/s and 22 to 44 Mc/s, harmonics being used for other local oscillator frequencies. Provision is made for connecting an external oscillator with an output of approximately 200 mV.

Calibration accuracy : $\pm 3\%$.

Crystal operation : Up to three crystals within the frequency range 22 to 44 Mc/s may be fitted, for use with input frequencies between 20.5 and 1000 Mc/s.

I.F. output

Frequency : 1.5 Mc/s.

Amplitude : Between approximately 250 and 750 mV e. m. f.

Output impedance : Nominally 10 k Ω .

L.F. output

Frequency range : 30 c/s to 150 kc/s with switchable 15 kc/s low-pass filter on f. m. 30 c/s to 50 kc/s on a. m.

De-emphasis : Switchable to 0, 50 or 75 μ sec.

Level : Nominally 0 dBm into 600 Ω when meter reads full-scale.

Distortion : Less than 0.25% for f. m. deviations up to ± 75 kc/s and modulation frequencies up to 15 kc/s,
 less than 0.5% for f. m. deviations up to ± 300 kc/s and modulation frequencies up to 25 kc/s,
 less than 3% for f. m. deviations up to ± 500 kc/s and modulation frequencies up to 150 kc/s.
 Less than 1% for a. m. depths up to 60%,
 less than 3% for a. m. depths up to 90%.

Power requirements

A. C. mains : 95 V to 130 V or 190 V to 260 V; 45 c/s to 500 c/s; 15 VA.

External battery : 21.5 V to 30 V d. c. ; 320 mA at 24 V d. c.

Dimensions and weight

Height	Width	Depth	Weight
7 3/4 in (19 cm)	18 1/2 in (47 cm)	14 1/4 in (36 cm)	30 lb (13.6 kg)

1.3 ACCESSORIES

Supplied

Extension Board type TM 7926; for use when servicing printed circuit boards.

Mains Lead type TM 7052.

Optional

Rack Mounting Conversion Kit type TM 8340.

Protective Cover type TM 7958/3; for protection of the front panel during transit.

Oscillator crystals. Marconi type QO1670 series; frequencies as specified in Section 2.15.

Shielded Adapter, type TB 39868 (Greenpar type GE 51002) for converting OUTPUT terminals to BNC coaxial socket.

R. F. Fuse Unit, type TM 9884.

2.1 INSTALLATION

The Modulation Meter type TF 2300 is available in two versions : with a case for bench mounting, or with a dust cover for rack mounting. The latter version, designated TF 2300R, fits a standard 19 inch rack.

Before inserting the TF 2300R into a rack, slides or runners should be fitted to the rack to support the instrument and aid location.

Transit precautions

To prevent damage being caused to the moving parts by shocks or vibrations in transit, a clip as shown in Fig. 2.1 is fitted. The tuning mechanism consists of a carriage running on a worm screw turned by the control knob; the carriage is mechanically coupled to ferrite tuning slugs in the variable inductors. The transit clip locks the carriage, and this must be released before the oscillator can be used. At the high frequency end of carriage travel, a tapped hole in the top of the brass carriage comes in line with a hole in

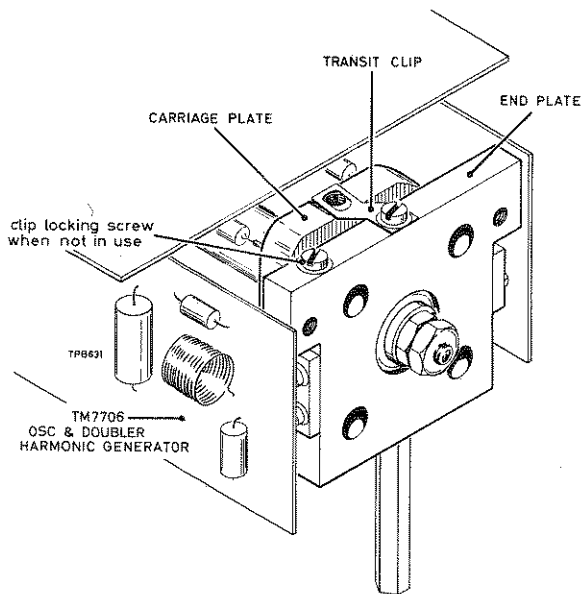

Fig. 2.1 Oscillator transit locking arrangement

the clip. A 6 BA screw, otherwise housed in a second hole to one side of the clip in the end plate is inserted through the clip and tightened down for long journeys, including delivery.

To reach the clip, release the four screws at the corners of the oscillator front panel and slide the oscillator partly out. For short journeys, the carriage need not be locked if the instrument is placed upright on a layer of padding, preferably with the tuning mechanism set to the high frequency limit of its travel.

Remove the locking screw before attempting to use the oscillator.

2.2 POWER SUPPLY

The modulation meter may be used with a.c. mains or batteries.

2.2.1 Mains supply, 110-230 V

The socket of the lead provided with this instrument fits into the plug on the rear panel. The other end of the lead must be fitted with a plug by the user. The three conductors are provided with identification sleeves for this purpose, as follows :

Colour	Connection	Sleeve	Symbol
Blue	Line	-	-
Black	Neutral	Black	White N
Yellow/Green	Earth	Yellow	Green

Before plugging in to the mains supply, check that the fuse rating and mains voltage setting are correct. For voltages around 230 V, a 100 mA fuse is fitted; for 110 V, this must be changed to 160 mA. Check that the h. t. fuse is 500 mA and note that it is a quick-blow type. To change the mains voltage switch setting, remove the L-shaped

lock-plate secured by two screws above the switch, slide the switch button into its other position (as shown on the panel), reverse and replace the lock-plate to hold the button in its new position. No other adjustment is needed.

Switch the MAINS -BATT switch to MAINS.

2.2.2 Battery operation

The modulation meter also works on 24 V batteries. A suitable supply would be a 24 V positive earth vehicle battery, on or off charge. Negative earth systems must not be used on any account, since the case of the instrument and its coaxial connections would be live. If a positive earth supply is not available, use dry cells. Six 4.5 V batteries, e. g. Exide type H30 or 3DT9, giving 27 V initially, should give several hours of service before their output drops below 21.5 V. This is equivalent to several weeks in normal use, provided that the instrument is switched off as soon as the measurement is completed. Current drain is 350 mA approximately. Observe correct polarity when connecting batteries to the back panel terminals; left is positive.

Switch the MAINS-BATT switch to BATT.

2.3 CONTROLS

The following outline of control functions is intended for reference purposes. Until you are familiar with the instrument, use the operating procedures detailed in later sections.

- ① Oscillator tuning dial. Shows effective internal local oscillator frequency.
- ② OSCILLATOR TUNE controls. (Outer : coarse - inner : fine). Adjust for dial reading 1.5 Mc/s above signal frequency. Inoperative when using external local oscillator.
- ③ CRYSTAL sockets. Accept style D miniature crystals for local oscillator control.
- ④ EXT OSC socket. Type BNC. Accepts external local oscillator signal of about 100 mV.
- ⑤ CRYSTAL switch. Selects crystal required. Switch to OFF when not crystal controlled.
- ⑥ RANGE switch. Selects internal local oscillator ranges as shown beside tuning dial, or external oscillator.
- ⑦ R. F. IN socket. Type BNC. Accepts signal under test.
- ⑧ I. F. OUT socket. Type BNC. Connect to counter for measuring carrier shift or to oscilloscope for viewing unfiltered a. m. envelope. Output is 1.5 Mc/s at about $\frac{1}{2}$ V.
- ⑨ LEVEL control. Adjusts attenuation of signal input at R. F. IN socket.
- ⑩ SET A. M. level control. Adjust for SET reading on meter when Function selector is at SET A. M.
- ⑪ Function switch. Selects setting up and measuring conditions on f. m. and a. m. Numbers show normal sequence of settings.
- ⑫ A. M./DEV RANGE switch. Selects full-scale meter range, five for f. m., two for a. m.
- ⑬ MAX MOD FREQ switch. Selects modulation bandwidth in f. m. measurements.
- ⑭ OUTPUT terminals. Provide demodulated output for connection to extra-sensitive meter, wave analyser etc.
- ⑮ Meter. Reads % a. m. depth and f. m. deviation. R. F. LEVEL arc applies to position 1 of Function switch, and SET mark to the four SET positions.
- ⑯ SET CAL F. M. preset. Standardizes deviation measuring accuracy. Adjust for SET reading on meter with Function switch at SET CAL.
- ⑰ DE-EMPHASIS switch. Applies de-emphasis to demodulated signal at OUTPUT terminals. Does not affect meter readout.
- ⑱ SUPPLY switch. Shows red segments when on. Works on both mains and battery operation.

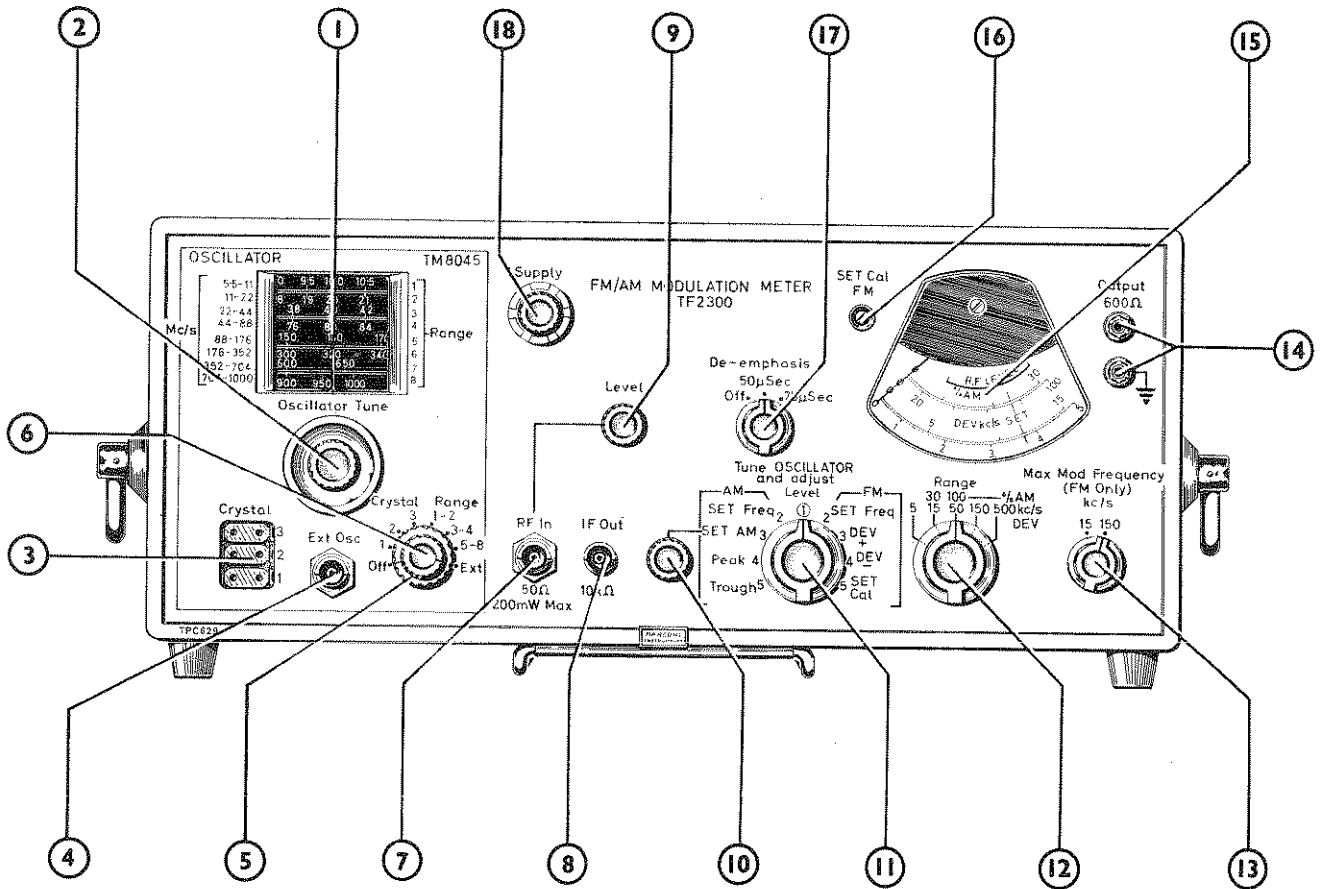

Fig. 2.2 Front panel controls

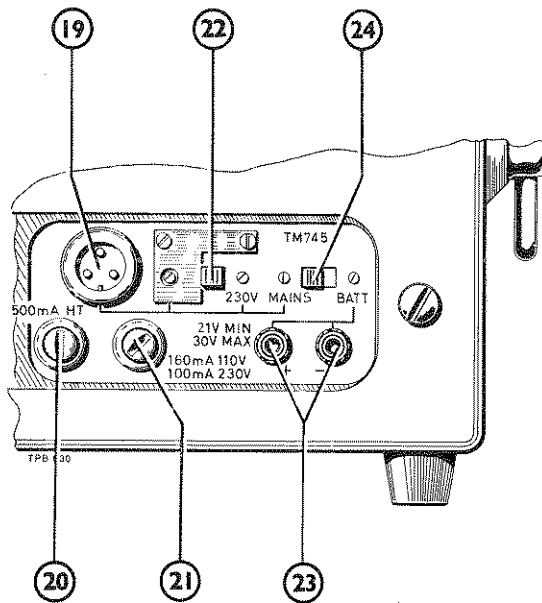

Fig. 2.3 Rear panel

- ①⑨ Supply plug. Accepts Mains Lead type TM 7052 for a. c. operation.
- ②⑩ H. T. fuse. 500 mA quick-blow type.
- ③⑪ Mains fuse. 100 mA (for 230 V a. c.) or 160 mA (for 110 V a. c.) slow-blow type.
- ④⑫ Mains voltage selector. 230 V position for 190-260 V, 110 V position for 90-130 V. Reverse locking plate when changing range.
- ⑤⑬ Battery terminals. 21-30 V d. c. floating or positive earth.
- ⑥⑭ MAINS/BATT switch. Select MAINS for a. c. supply to plug, BATT for d. c. supply to terminals.

2.4 PREPARATION FOR USE

It is helpful in reading these instructions and in using the instrument until completely familiar with its operation, to remember that where a control or switch position is marked SET, the control should be adjusted to make the meter read on the line marked SET.

Before commencing measurements :

(1) Check the mechanical zero of the meter and adjust, if necessary, by means of the screw.

(2) Turn the LEVEL control towards minimum (counter-clockwise).

(3) Connect the signal to be tested to the R. F. IN socket at a level which, operating into 50 Ω , will develop a voltage within the limits given in section 1.2 under 'R. F. input'. At the highest carrier frequencies the shortest possible input lead should be used or an external 50 Ω matching attenuator.

CAUTION Inputs greater than 3 V r. m. s. may damage the attenuator. If in doubt, use an external attenuator.

(4) Turn the SUPPLY switch clockwise so that the red segments show.

2.5 MEASURING F.M. DEVIATION

After carrying out the preparation procedure in section 2.4 :

- (1) Set the A. M./DEV RANGE switch (below the meter) to suit the expected deviation of the signal under test.
- (2) Set the MAX MOD FREQUENCY switch to 150 kc/s unless the modulating frequency is less than 15 kc/s. If so, switch to 15 kc/s in order to obtain the best signal-to-noise ratio.
- (3) Set the DE-EMPHASIS switch as required. Its setting has no effect on the internal meter reading but it is effective on the demodulated signal at the OUTPUT terminals.

TABLE 2.1
Frequency ranges

RANGE switch setting	Range	Osc. freq. Mc/s	R.F. input freq. Mc/s
1-2	1	5.5 - 11	4.0 - 9.5
	2	11 - 22	9.5 - 20.5
3-4	3	22 - 44	20.5 - 42.5
	4	44 - 88	42.5 - 86.5
5-8	5	88 - 176	86.5 - 174.5
	6	176 - 352	174.5 - 350.5
	7	352 - 704	350.5 - 702.5
	8	701.5 - 1001.5	700 - 1000
EXT	-	F + 1.5	F

(4) Set the oscillator RANGE switch in accordance with table 2.1. For detailed instructions on oscillator arrangements, see section 2.10. In this section, it is assumed that the internal local oscillator will be used.

(5) Set the Function switch to TUNE OSCILLATOR AND ADJUST LEVEL. Adjust the OSCILLATOR TUNE dial to a frequency 1.5 Mc/s above the carrier. Tune for peak meter deflection, and then adjust LEVEL for a meter deflection in the black R. F. LEVEL arc, preferably near the top end for best signal-to-noise ratio.

(6) Set the Function switch to F. M. SET FREQ. Slightly readjust the OSCILLATOR TUNE control until the meter deflects to the SET line. Avoid spurious settings - the correct one is the closest to the original setting obtained in (5).

(7) Set the Function switch to DEV + and DEV-. The demodulated peak frequency deviations above and below the carrier frequency may be measured on the meter or viewed on an oscilloscope connected to the OUTPUT terminals. Read the meter on the scale corresponding to the setting of the A. M./DEV RANGE switch.

Note : If unequal readings are obtained, distortion in the equipment under test is indicated. See section 2.12.

(8) Before carrying out a series of measurements, and from time to time during measurements,

switch to SET CAL and check that the meter reads SET. If necessary, adjust the f. m. calibration by inserting a screwdriver in the SET CAL F. M. preset and adjusting until the meter reads SET.

Noise in f.m. measurements

To accommodate signals with up to 100% amplitude modulation the maximum r. f. input level, as indicated by full-scale deflection on the black meter arc, is set at 6 dB below the maximum amplitude which the i. f. amplifier can handle. When making measurements on f. m. signals including f. m. noise, and f. m. on a. m., this extra level capability of the i. f. amplifier can be used with advantage to reduce the internally generated noise to a minimum. This is useful when measuring noise on signal sources or when measuring deviations in the 5 kc/s range on the 150 kc/s bandwidth so that errors due to noise are minimized.

The optimum r. f. level is set by monitoring the i. f. signal at the I. F. OUT socket and adjusting the r. f. input level for the maximum undistorted i. f. signal. Alternatively, if no means of monitoring the i. f. signal is available, it is sufficient to increase the r. f. input level until the noise signal being measured is at a minimum, or if deviation is being measured, until the deviation reading is at a minimum.

2.6 MEASURING A.M. DEPTH

After carrying out the preparation procedure in section 2.4 :

- (1) Set the A. M./DEV RANGE switch (below the meter) to the 30% or 100% a. m. depth range according to the expected modulation depth of the signal under test.
- (2) Set the oscillator RANGE switch in accordance with table 2.1. For detailed instructions on oscillator arrangements, see section 2.10. In this section, it is assumed that the internal local oscillator will be used.
- (3) Set the Function switch to TUNE OSCILLATOR AND ADJUST LEVEL. Adjust the OSCILLATOR TUNE dial to a frequency of 1.5 Mc/s above the input frequency. Tune for peak

deflection and then adjust LEVEL to give a meter deflection in the black R. F. LEVEL arc, preferably towards the lower end for best mixing and hence minimum distortion.

- (4) Set the Function switch to A. M. - SET FREQ. Slightly readjust the OSCILLATOR TUNE control until the meter deflects to the SET line. Avoid spurious settings - the correct one is the closest to the original setting obtained in (3).
- (5) Set the Function switch to SET A. M. Adjust the adjacent SET A. M. control until the meter reads on the SET line. Note that this setting can be done with or without modulation since the adjustment is to the mean level of the i. f. signal. However, appreciable even harmonic distortion can affect the setting accuracy and, in such circumstances, it is preferable to set up without modulation.
- (6) Set the Function switch to A. M. PEAK. Read the percentage modulation depth at the peak.
- (7) Set the Function switch to A. M. TROUGH. Read the percentage modulation depth at the trough.

When the peak and trough readings are unequal, distortion is present in the input signal.

2.7 MEASURING F.M. ON A.M.

To measure the spurious f. m. on an amplitude modulated source, proceed as for f. m. measurement, section 2.5.

A certain amount of spurious f. m. is introduced by the instrument itself. When the carrier is deeply modulated, at high modulating frequencies, this should be taken into consideration, but below 40% depth in the audio range of frequencies the spurious deviation is not very significant. At 80% depth and 1 kc/s frequency, the maximum spurious deviation is less than 500 c/s referred to the 15 kc/s bandwidth.

Tables 2.2 and 2.3 give typical results which should be used for general guidance purposes only.

TABLE 2.2

Spurious deviations with increasing % a.m.

1. LEVEL control set for meter reading at top end of arc.
2. A. M. frequency = 1 kc/s

A.M.	Spurious deviation	
	15 kc/s bandwidth	150 kc/s bandwidth
30	< 500 c/s	< 1 kc/s
80	< 500 c/s	2 kc/s

TABLE 2.3

Spurious deviations with increasing a.m. frequency

1. LEVEL control set for meter reading at top end of arc.
2. A. M. depth = 80%.

A.M. freq.	Spurious deviation	
	15 kc/s bandwidth	150 kc/s bandwidth
1 kc/s	< 500 c/s	2 kc/s
10 kc/s	1 kc/s	3 kc/s
100 kc/s	-	7 kc/s

2.8 MEASURING A.M. ON F.M.

The modulation meter may be used to indicate amplitude modulation in a frequency modulated signal, provided that the deviation is less than 100 kc/s. The procedure is that of a. m. measurement, section 2.6.

In general, the spurious a. m. indication will be proportional to the deviation. The i. f. amplifier is set up for optimum phase response for f. m. deviation measurement rather than a maximally flat response for measuring a. m. on f. m.

Below 100 kc/s deviation, the internally generated spurious a. m. is less than 2% approximately.

2.9 NOISE MEASUREMENTS

By connecting an external meter to the OUTPUT terminals, noise measurements limited

only by the noise level generated within the instrument can be made. The internal meter, being peak reading, is not suitable for measuring noise and, ideally, an r. m. s. responding meter should be used. However, sufficiently accurate results are usually obtained with an average reading meter by applying the appropriate correction factor.

Typical meters which can be used are as follows :

- (a) R. M. S. valve voltmeter capable of measuring to the necessary accuracy (1% deviation on any range is approximately 7.75 mV). Errors due to crest factor and zero shift can be avoided by operating the meter at mid-scale by means of an attenuator.
- (b) Marconi Instruments Sensitive Valve Voltmeter, type TF 2600.
- (c) Marconi Instruments Distortion Factor Meter, type TF 2331.

(b) and (c) are average reading and a correction of +1 dB should be applied.

- (1) The modulation meter has two selectable f. m. bandwidths and the appropriate filter must be selected when making the test.

A capacitor should be connected across the OUTPUT terminals - 0.014 μ F for the 15 kc/s bandwidth, or 0.0013 μ F for 150 kc/s. These corrective capacitors are necessary because of the design of the filters (see section 3.9).

For optimum results in the 15 kc/s bandwidth position a low-pass filter as shown below should be used between the OUTPUT terminals and the external meter instead of the capacitor.

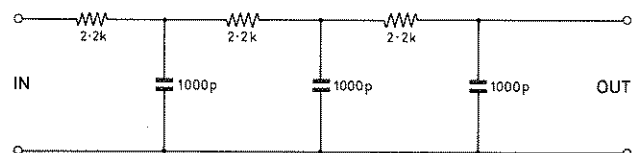

For noise measurements in other bandwidths select the MAX MOD FREQUENCY 150 kc/s bandwidth setting and use a similar type of low-pass filter designed for the required cut-off frequency.

- (2) The output of the modulation meter is 0.775 V into 600 Ω for full-scale deflection on the internal meter.
- (3) For measurements in the r. f. range 22 Mc/s to 1000 Mc/s the local oscillator must be crystal controlled if lowest possible internally generated noise is required. Thus, a crystal suitable for the appropriate frequency must be available.

This is not a requirement below 22 Mc/s, where the internal noise of the oscillator is sufficiently low to make crystal control unnecessary.

- (4) The curves given in Fig. 2.4 show typical noise levels produced by free-running and crystal controlled oscillators over the r. f. range of the instrument. In the 15 kc/s bandwidth, below 70 to 100 Mc/s, there is insignificant difference in respective noise levels. Above 100 Mc/s, however, the noise level free-running increases progressively with frequency, whereas under crystal control the level remains nearly constant. The necessity to use crystal control depends on the noise level of the equipment under test and, as shown by the curves, the band-

width in which the measurement is to be made and the carrier frequency.

In the 150 kc/s bandwidth, there is little advantage in using crystal control below 500 Mc/s. In both bandwidths, crystal control will eliminate oscillator microphony and therefore may be advantageous in conditions of vibration or high acoustic noise levels.

F.M. noise

- (1) Connect an external meter to the OUTPUT terminals. Apply r. f. input at a suitable level.
- (2) Adjust the OSCILLATOR TUNE dial to a frequency 1.5 Mc/s above the carrier and tune for peaking, as in section 2.5 (5). Then adjust LEVEL to the top end of the black arc on internal meter. Switch to 15 kc/s or 150 kc/s MAX MOD FREQUENCY setting, thus selecting the required low-pass filter in the modulation meter.

(See also Sect. 2.5 - Noise in f. m. measurements.)

- (3) Switch to position F. M. SET FREQ and adjust the oscillator until meter reads SET.
- (4) Switch to crystal control and check that the meter still reads near to the SET mark - the

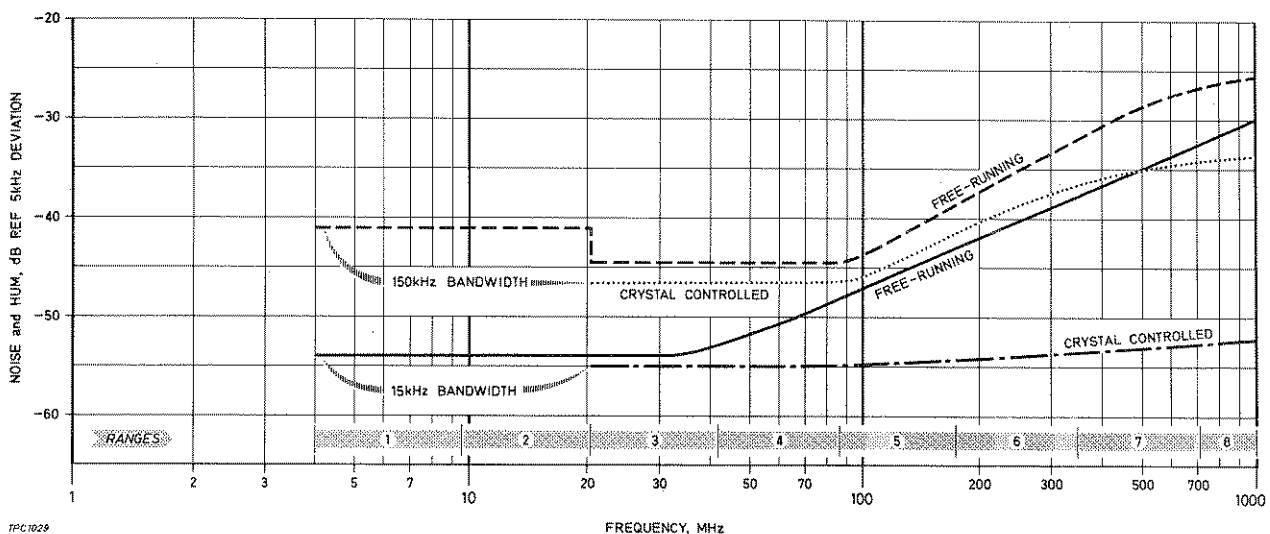

Fig. 2.4 Typical modulation meter noise levels

actual reading will depend on frequency tolerances in the source and local oscillator output. Switch to DEV +.

- (5) Modulate the carrier to the reference deviation and select the appropriate range on the A. M./DEV RANGE switch.
- (6) Read the external meter and record the dB level.
- (7) Remove the modulation from the signal under test. Turn the A. M./DEV RANGE switch to its most sensitive range and then increase the sensitivity of the external meter to give a convenient reading. Record the new level, which is given by the reading on the external meter plus 10 dB for each step of the A. M./DEV RANGE switch.
- (8) The signal-to-noise ratio referred to the selected bandwidth in which the measurements were made is given by the difference between the levels measured in (6) and (7).

A.M. noise

- (1) Connect an external meter to the OUTPUT terminals. Apply r. f. input at a suitable level.
- (2) Adjust the OSCILLATOR TUNE dial to a frequency 1.5 Mc/s above the carrier and tune for peaking, as in section 2.6 (3). Then adjust LEVEL to the top end of the black arc on internal meter.
- (3) Switch to position A. M. SET FREQ and adjust the oscillator until the meter reads SET.
- (4) Switch to crystal control and check that the meter still reads near to the SET mark - the actual reading will depend on frequency tolerances in the source and local oscillator output. Switch to A. M. PEAK.
- (5) Modulate the carrier to the reference depth and select the appropriate range on the A. M./DEV RANGE switch.
- (6) Read the external meter and record the dB level.
- (7) Remove the modulation from the signal under test. Turn the A. M./DEV RANGE switch to

its most sensitive range and then increase the sensitivity of the external meter to give a convenient reading. Record the new level, which is given by the reading on the external meter plus 10 dB for each step of the A. M./DEV RANGE switch.

- (8) The signal-to-noise ratio is given by the difference between the levels measured in (6) and (7).

2.10 OSCILLATOR ARRANGEMENTS AND OPERATING NOTES

The same procedure applies for both f. m. and a. m. measurements. The basic requirement is for a stable frequency source 1.5 Mc/s higher than the signal under test, and this can be obtained from three sources :

- (a) The internal permeability-tuned variable oscillator usable at all frequencies between 4 and 1000 Mc/s.
- (b) The internal crystal controlled spot-frequency oscillator, usable with selected crystals over the range of 20 to 1000 Mc/s.
- (c) An external oscillator with an output of 100 mV across 50 Ω .

2.10.1 Variable oscillator

Choose the appropriate range on the RANGE switch.

Check that the CRYSTAL selector is at OFF.

Rotate the TUNE dial with the coarse and fine controls to a setting 1.5 Mc/s above the frequency of the input signal. Note that there are meter peaks 1.5 Mc/s above and below the carrier frequency; always tune the oscillator to the higher frequency for correct polarity sense of the Function switch.

Adjust the fine control from time to time, to bring the meter reading to the SET mark when switched to the SET FREQ position. It is permissible to tune to another internal oscillator harmonic as this will not affect the readings obtained.

The oscillator takes about two minutes to stabilize after turning on, but this is only of any significance at very high frequencies.

2.10.2 Crystal-controlled oscillator

Plug in a crystal of the required frequency as selected in section 2.15.

Select the appropriate position on the RANGE switch and set the oscillator dial to the crystal frequency. Set the CRYSTAL selector to the crystal position number.

Slight tuning on position TUNE OSCILLATOR of the Function switch may be necessary to obtain maximum sensitivity at the higher frequencies. Do not tune far off the original setting to avoid any possibility of mode jumping.

Proof that the oscillator is under crystal control can be obtained by setting the Function switch to SET FREQ and rocking the tuning control. If the oscillator is under control the meter reading will not vary.

In general, the tuning control is set to the required oscillator frequency, but provided the crystal frequencies do not differ too widely, any of the crystals can be selected without re-setting the tuning control between selections.

2.10.3 External oscillator

If a stable frequency source is available, it may be preferable to use it rather than the internal oscillator. Feed the external oscillator signal into the EXT OSC socket and turn the RANGE switch to EXT. An input level of 100 mV into 50 Ω is required at a frequency 1.5 Mc/s above the input signal frequency.

The primary use of this facility is for measurement on r. f. signals which contain harmonics of less than 20 dB down on the fundamental. Because the internal oscillator signal also contains harmonics, mixing two such signals can give rise to spurious results. A 'pure' local oscillator signal prevents this happening.

Secondly, if an external crystal oscillator is available, it may be preferred to use this, rather than to crystal control the local oscillator, for low level noise measurements.

Thirdly, the carrier frequency range may be extended from 1000 Mc/s to approximately 2500 Mc/s by using a suitable external oscillator. In this range, however, the sensitivity may deteriorate.

2.11 MEASUREMENT IN 1 TO 2 Mc/s RANGE

The instrument can accept signals in the band 1 to 2 Mc/s, applied directly to R. F. IN, with the oscillator switched off. Input sensitivity is the same as usual. Ensure the modulation frequency does not take the frequency beyond the band limits quoted, so as to avoid introducing distortion caused by the reduced gain outside the pass band.

Operating the instrument in this way cuts out the frequency inversion caused by the heterodyne system normally used. The polarity of the DEV + and DEV - positions of the Function switch is therefore reversed.

2.12 ASYMMETRIC MODULATION AND CARRIER SHIFT

The presence of asymmetric modulation usually indicates distortion in the equipment under test, and is revealed by unequal meter readings when the Function switch is turned between PEAK and TROUGH or DEV+ and DEV-.

To make sure that the asymmetry is due to the input signal, and not introduced by the instrument, retune the oscillator to the lower peak, 1.5 Mc/s below the carrier frequency. If the asymmetry is reversed, i. e. , the original DEV + reading now appears at DEV -, and vice versa, the asymmetric modulation can be attributed to the input signal.

In position SET FREQ, the output from a counter circuit in the limiter is measured by the meter. When the meter indicates SET, the i. f. is centred on 1.5 Mc/s exactly. If modulation then causes the meter reading to fluctuate, carrier shift is present. The extent of the shift may be measured by connecting a counter to I. F. OUT. In cases of severe carrier shift, the modulation meter must be set up with modulation on.

2.13 USE OF L.F. OUTPUT TERMINALS

CAUTION Application of d. c. to these terminals will cause damage - see section 3.10.

These terminals enable the modulation waveform on the input signal to be monitored or analysed. They also enable a sensitive external meter to be used to extend the deviation range down to the level of residual noise within the instrument.

The terminals are fed by an independent output stage in the 2nd l. f. amplifier and therefore the internal meter is unaffected by loads connected to them.

Depending on the position of the Function switch, a. m. or f. m. demodulated outputs are obtained. The output impedance is approximately 600 Ω and the open circuit level approximately 1.5 V for full-scale deflection on the internal meter.

Note : For most purposes, the output can be terminated with 600 Ω or unterminated. In the latter case, a voltage due to leakage of C11 may appear at the output, causing difficulty if a d. c. coupled oscilloscope is used at high sensitivity.

The l. f. response is substantially level up to 150 kc/s. The output is also available with switched 50 μ sec or 75 μ sec de-emphasis to restore the modulation characteristic of signals that have had pre-emphasis applied.

2.14 USE OF I.F. OUT SOCKET

This socket can be used to measure carrier shift by connecting a counter to it - see section 2.6 - or to view the a. m. envelope on an oscilloscope.

It may also be used to measure amplitude modulation above 50 kc/s which normally would not be passed by the a. m. detector. This is an extended use of the modulation meter which in practice would probably be limited by the attenuation of the 10 k Ω output resistance and the input capacitance of the measuring instrument.

2.15 CRYSTAL SELECTION

Crystal control of the local oscillator reduces microphony and pick-up from surrounding equipment where these effects cannot be avoided. At higher frequencies, distortion due to noise in the oscillator can be significantly reduced. Up to three crystals can be plugged into sockets on the oscillator front panel and any one can be selected by the red coloured section of the oscillator RANGE switch.

A recommended crystal is a 3rd overtone series resonant Marconi type QO1670F150/A/S with a specified frequency between 22 and 44 Mc/s. Thus, the crystal is used on its fundamental on Range 3 and appropriate harmonics on the other and higher ranges. These crystals are in hermetically sealed, style D miniature cases conforming to British Standard and U. S. Style HC6U.

The following simplifies the procedure for establishing the required crystal frequency for any specified r. f. input between 20.5 and 1000 Mc/s :

- 1) Add 1.5 Mc/s to the r. f. input frequency.
- 2) Divide this sum by the local oscillator harmonic factor found from Table 2.4 (shown opposite the range applicable to the r. f. input). This result is the crystal frequency.
- 3) Expressing 1) and 2) as a formula :

$$\text{Crystal frequency} = \frac{(\text{R. F.} + 1.5) \text{ Mc/s}}{\text{Harmonic factor}}$$

TABLE 2.4

Range no.	R.f. input frequency Mc/s	Local oscillator harmonic factor
1	4 - 9.5	No crystal control on this range
2	9.5 - 20.5	No crystal control on this range
3	20.5 - 42.5	1
4	42.5 - 86.5	2
5	86.5 - 174.5	4
6	174.5 - 350.5	8
7	350.5 - 702.5	16
8	702.5 - 1000	24

Example : To find the fundamental crystal frequency for an r. f. input of 83.666 Mc/s :

- 1) Consulting Table 2.4, it can be seen that this r. f. falls within range 4 and the harmonic factor is therefore 2.

$$\text{Crystal frequency} = \frac{83.666 + 1.5}{2} = 42.583 \text{ Mc/s}$$

A $\pm 10\%$ tolerance is permitted on the 1.5 Mc/s i. f. (± 150 kc/s) and, since the normal tolerance on crystal frequency for $+20^{\circ}\text{C}$ to $+60^{\circ}\text{C}$ temperature operation is $\pm 0.01\%$, a crystal with a frequency of 42.58 Mc/s and normal tolerance should be suitable and it is not usually necessary to specify a tighter tolerance.

Note : Where f. m. deviation approaches the full i. f. bandwidth and the r. f. approaches 1000 Mc/s, the crystal tolerance should be as close as possible for minimum distortion and crystals with tighter frequency limits ($\pm 0.003\%$) should be specified.

In every case the crystal frequency selected should be such that the lowest possible harmonic factor gives the required operating frequency. This is automatically given by Table 2.4 using the procedure described.

Example : Required oscillator frequency is 176 Mc/s.

- 1) It can be seen that a crystal of 22 Mc/s operating with a harmonic factor of 8 will satisfy frequency conditions.
- 2) However, a crystal of 44 Mc/s operating with a harmonic factor of 4 should be specified for maximum output from the oscillator.

Fig. 2.5 Frequency spectrum of f.m. stereo signal with 1 kc/s modulating tone

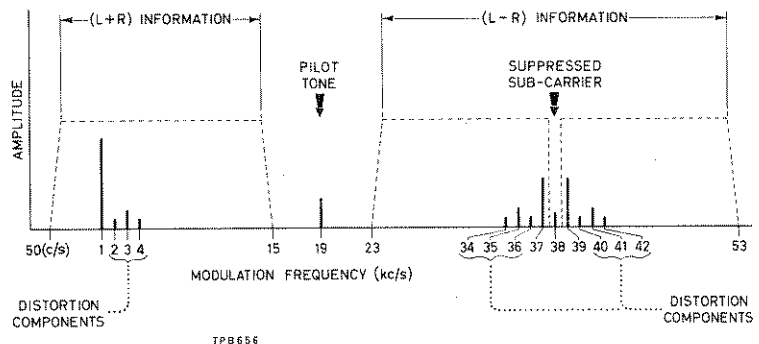

Crystals are fully specified in Data Sheet QO1670F, to which reference should be made for further details if required. Both data sheet and crystals are available from The Marconi Co. Ltd., Chelmsford, Essex.

2.16 F.M. STEREO MEASUREMENTS

Distortion and channel separation in stereo systems which are designed to meet U. S. Federal Communications Commission (F. C. C.) requirements can be measured with the TF 2300 Modulation Meter. The general procedures are described in the following sections.

2.16.1 Harmonic distortion

It can be assumed that distortion introduced by the modulation meter is small in comparison with that in stereo transmitters, being typically better than 0.2% for deviations up to ± 75 kc/s and therefore, for practical purposes, can be ignored.

The typical frequency spectrum of a G. E. - Zenith type of f. m. stereo signal when a 1 kc/s test tone (for example) is applied to the left channel and no signal to the right, is shown in Fig. 2.5.

Ideally, only the fundamental 1 kc/s signal in the left + right (L + R) channel and the 37 and 39 kc/s sidebands of the suppressed sub-carrier in the L - R channel should be present. In practice, however, harmonic distortions will occur at 2, 3, 4 kc/s . . . in the L + R channel and at 37 and 39, 36 and 40, 35 and 41 kc/s . . . in the L - R channel. These are the distortion components which it is desired to measure.

The test arrangement for measuring distortion in an f. m. stereo transmitter is shown for measurements on the G. E. -Zenith system is given below :-

- (1) Connect the transmitter output to the modulation meter in accordance with section 2.4 - Preparation for Use.
- (2) Set up the modulation meter with the transmitter signal on, in accordance with section 2.5 - Measuring F. M. Deviation.

The following notes are intended to amplify the setting instructions and refer specifically to the G. E. -Zenith System.

- (3) Set the controls as follows :-
 A. M. /DEV RANGE : 150 kc/s.
 MAX MOD FREQ : 150 kc/s.
 DE-EMPHASIS : OFF, even if pre-emphasis is being applied.

Function : DEV + or DEV -

- (4) Apply a test signal of a chosen frequency to the left channel with no signal to the right channel.
- (5) Connect Wave Analyser type TF 2330, or an equivalent instrument for harmonic analysis of the audio range, to the OUTPUT terminals of the modulation meter. (Refer to the instruction manual on the analyser for calibration and measuring procedures.)
- (6) The frequency spectrum of the demodulated output of the modulation meter can be obtained by tuning through the frequency range and taking measurements at the appropriate frequencies. The result is usually referred to the fundamental and expressed as percentages or dB readings, calculated by the usual method for harmonic distortion measurement as described in the wave analyser manual.

Fig. 2.6 Test arrangement for measuring distortion



For practical working purposes, the small amount of distortion introduced by the modulation meter can be neglected.

2.16.2 Channel separation

If it were possible to view the 50 c/s to 15 kc/s and the 23 to 53 kc/s regions of Fig. 2.5 separately, the waveforms shown in Figs. 2.7 (a) and (b) would be seen.

The ideal composite modulating signal with the 19 kc/s pilot tone removed should be the sum of these waveforms as shown in (c). In practice, there will be amplitude unbalance and relative phase shift (group delay error) between the two added signals. These two effects, which can be viewed on a direct coupled oscilloscope, are illustrated in (d) and (e), where amplitude 'B' represents a signal on the right channel due to an input on the left channel.

Channel 1 separation is given by :

$$\text{Separation} = 20 \log_{10} \frac{A}{B} \quad \dots (1)$$

where A and B are measurements indicated in Figs. 2.7 (d) and (e).

An f. m. stereo transmitter or stereo modulator must meet specified requirements as regards response and phase shift. In the F. C. C. requirements, it is deemed that these are met if the channel separation exceeds 29.7 dB.

A suitable oscilloscope, such as a Marconi Instruments type TF 2200, connected to the OUTPUT terminals of the modulation meter, enables the channel separation to be measured. Fig. 2.8 shows typical oscillograms obtained on a TF 2200 Oscilloscope from which such measurements would be made.

From 200 c/s to 15 kc/s, the channel separation figure of the modulation meter is typically 13 dB below the minimum required of f. m. stereo channels in the F. C. C. regulations, while at 50 c/s (the worst condition), it is at least 3 dB below.

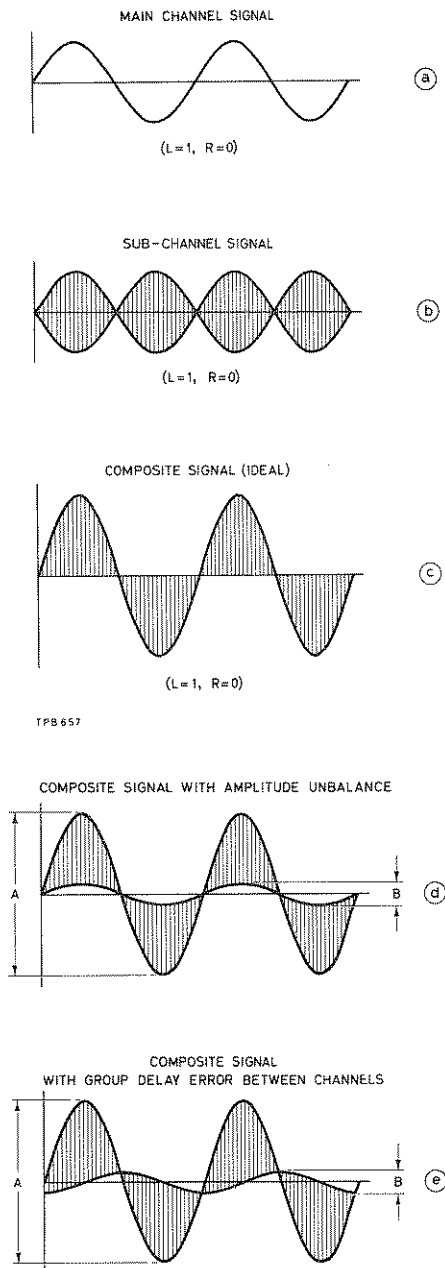

Fig. 2.7 Derivation of composite stereo signal showing unbalance and phase shift errors

The test arrangement for measuring channel separation is as illustrated in Fig. 2.6, except that the wave analyser is now replaced by an oscilloscope, and the procedure is as follows :-

- (1) Set up the equipment and modulation meter as already described for distortion measurements.

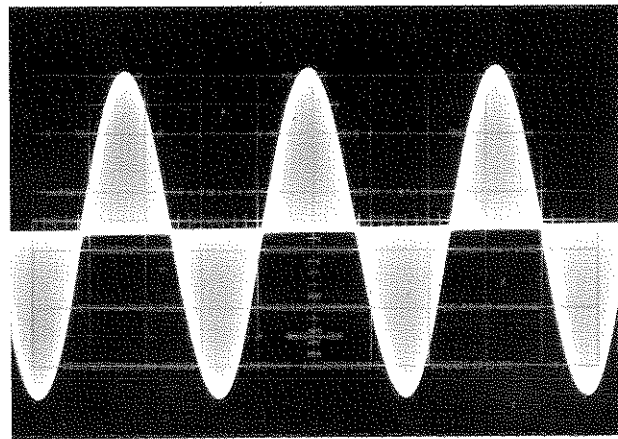

Fig. 2.8 (a) Ideal

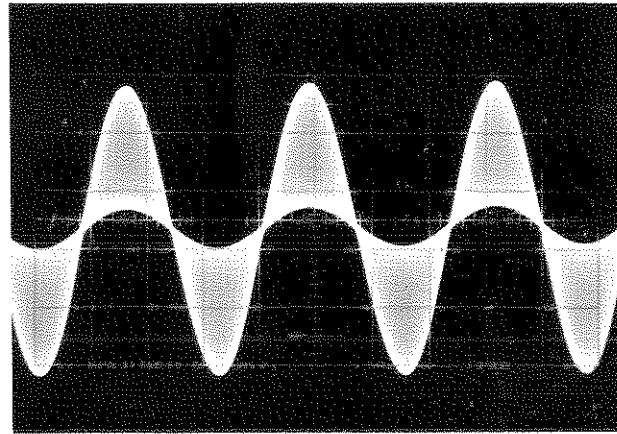

Fig. 2.8 (b) With amplitude unbalance

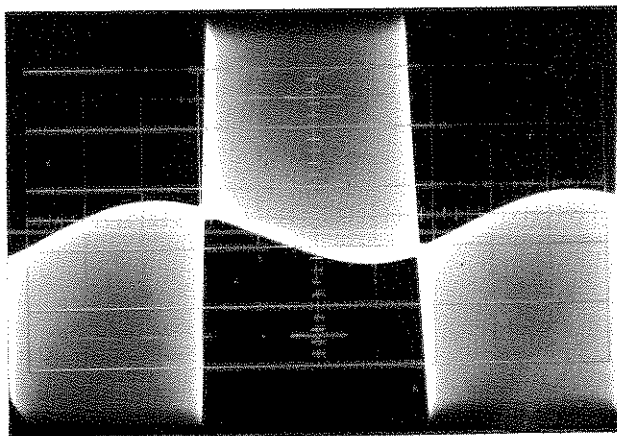

Fig. 2.8 (c) With phase shift error

Oscillograms of composite signal

- (2) Apply a test signal to the left channel at 15 kc/s modulation frequency (for example) with no signal on the right channel.
- (3) Connect the oscilloscope, switched to d. c. coupling, to the OUTPUT terminals of the modulation meter. If the oscilloscope has a high input resistance it is advisable to connect a resistor of about 1 k Ω (the exact value is unimportant) in parallel with the oscilloscope input; this is to prevent leakage in the electrolytic output coupling capacitor of the modulation meter from producing a voltage which may shift the trace off the screen. Adjust the oscilloscope to suitable time base and input attenuator settings for a composite signal waveform as in Fig. 2. 8. Procedure here depends on the equipment being tested, in general it consists of setting up the system for deviation, and gain etc. , in accordance with individual system manufacturers' instructions until a satisfactory waveform is seen. The gain of the L - R channel should then be adjusted for minimum amplitude 'B'. Measure this amplitude and calculate separation in accordance with formula (1).

2.17 PHASE MODULATION AND TELEMETRY DEVIATION

Phase modulation

To find the degree of phase modulation,

measure the deviation and divide by the modulating frequency to obtain the answer in radians.

Telemetry deviation

To measure the deviations in a modulated telemetry signal connect the OUTPUT terminals to the external meter via a switched series of band-pass filters at the sub-carrier frequencies. This enables the deviation due to each tone to be measured, having first calibrated the meter against a signal modulated by a single tone.

2.18 STRAY FIELDS

The oscillator uses permeability tuning and so the oscillator frequency may be modulated by stray magnetic fields. An internal magnetic screen is fitted but nevertheless we recommend that the oscillator section of the instrument should not be placed close to other devices having strong external magnetic fields.

The instrument has internal screening which, for most purposes, provides adequate attenuation from stray fields. However, a signal source such as a transmitter of greater power than about 10 W may cause stray electric r. f. radiation which may be picked up by the deviation meter. This means that it may be necessary to take care in the siting of the instrument. The effect will be most noticeable when making a. m. measurements; f. m. measurements will be affected only if the stray field is so great as to pass the limiters.

DECIBEL CONVERSION TABLE

<i>Ratio Down</i>			<i>Ratio Up</i>		
VOLTAGE	POWER	DECIBELS	VOLTAGE	POWER	
1.0	1.0	0	1.0	1.0	
.9886	.9772	.1	1.012	1.023	
.9772	.9550	.2	1.023	1.047	
.9661	.9333	.3	1.035	1.072	
.9550	.9120	.4	1.047	1.096	
.9441	.8913	.5	1.059	1.122	
.9333	.8710	.6	1.072	1.148	
.9226	.8511	.7	1.084	1.175	
.9120	.8318	.8	1.096	1.202	
.9016	.8128	.9	1.109	1.230	
.8913	.7943	1.0	1.122	1.259	
.8710	.7586	1.2	1.148	1.318	
.8511	.7244	1.4	1.175	1.380	
.8318	.6918	1.6	1.202	1.445	
.8128	.6607	1.8	1.230	1.514	
.7943	.6310	2.0	1.259	1.585	
.7762	.6026	2.2	1.288	1.660	
.7586	.5754	2.4	1.318	1.738	
.7413	.5495	2.6	1.349	1.820	
.7244	.5248	2.8	1.380	1.905	
.7079	.5012	3.0	1.413	1.995	
.6683	.4467	3.5	1.496	2.239	
.6310	.3981	4.0	1.585	2.512	
.5957	.3548	4.5	1.679	2.818	
.5623	.3162	5.0	1.778	3.162	
.5309	.2818	5.5	1.884	3.548	
.5012	.2512	6	1.995	3.981	
.4467	.1995	7	2.239	5.012	
.3981	.1585	8	2.512	6.310	
.3548	.1259	9	2.818	7.943	
.3162	.1000	10	3.162	10.000	
.2818	.07943	11	3.548	12.59	
.2512	.06310	12	3.981	15.85	
.2239	.05012	13	4.467	19.95	
.1995	.03981	14	5.012	25.12	
.1778	.03162	15	5.623	31.62	

DECIBEL CONVERSION TABLE (continued)

Ratio Down		DECIBELS	Ratio Up	
VOLTAGE	POWER		VOLTAGE	POWER
.1585	.02512	16	6.310	39.81
.1413	.01995	17	7.079	50.12
.1259	.01585	18	7.943	63.10
.1122	.01259	19	8.913	79.43
.1000	.01000	20	10.000	100.00
.07943	6.310×10^{-3}	22	12.59	158.5
.06310	3.981×10^{-3}	24	15.85	251.2
.05012	2.512×10^{-3}	26	19.95	398.1
.03981	1.585×10^{-3}	28	25.12	631.0
.03162	1.000×10^{-3}	30	31.62	1,000
.02512	6.310×10^{-4}	32	39.81	1.585×10^3
.01995	3.981×10^{-4}	34	50.12	2.512×10^3
.01585	2.512×10^{-4}	36	63.10	3.981×10^3
.01259	1.585×10^{-4}	38	79.43	6.310×10^3
.01000	1.000×10^{-4}	40	100.00	1.000×10^4
7.943×10^{-3}	6.310×10^{-5}	42	125.9	1.585×10^4
6.310×10^{-3}	3.981×10^{-5}	44	158.5	2.512×10^4
5.012×10^{-3}	2.512×10^{-5}	46	199.5	3.981×10^4
3.981×10^{-3}	1.585×10^{-5}	48	251.2	6.310×10^4
3.162×10^{-3}	1.000×10^{-5}	50	316.2	1.000×10^5
2.512×10^{-3}	6.310×10^{-6}	52	398.1	1.585×10^5
1.995×10^{-3}	3.981×10^{-6}	54	501.2	2.512×10^5
1.585×10^{-3}	2.512×10^{-6}	56	631.0	3.981×10^5
1.259×10^{-3}	1.585×10^{-6}	58	794.3	6.310×10^5
1.000×10^{-3}	1.000×10^{-6}	60	1,000	1.000×10^6
5.623×10^{-4}	3.162×10^{-7}	65	1.778×10^3	3.162×10^6
3.162×10^{-4}	1.000×10^{-7}	70	3.162×10^3	1.000×10^7
1.778×10^{-4}	3.162×10^{-8}	75	5.623×10^3	3.162×10^7
1.000×10^{-4}	1.000×10^{-8}	80	1.000×10^4	1.000×10^8
5.623×10^{-5}	3.162×10^{-9}	85	1.778×10^4	3.162×10^8
3.162×10^{-5}	1.000×10^{-9}	90	3.162×10^4	1.000×10^9
1.000×10^{-5}	1.000×10^{-10}	100	1.000×10^5	1.000×10^{10}
3.162×10^{-6}	1.000×10^{-11}	110	3.162×10^5	1.000×10^{11}
1.000×10^{-6}	1.000×10^{-12}	120	1.000×10^6	1.000×10^{12}
3.162×10^{-7}	1.000×10^{-13}	130	3.162×10^6	1.000×10^{13}
1.000×10^{-7}	1.000×10^{-14}	140	1.000×10^7	1.000×10^{14}

3.1 SYSTEM OPERATION

General operation of the TF 2300 Modulation Meter can be explained with reference to the block schematic, Fig. 3.1.

The r. f. input is heterodyned in the mixer with the local oscillator output, producing an intermediate frequency signal of 1.5 Mc/s. The output of the mixer is fed to an i. f. amplifier which has a linear phase/frequency response to f. m.

From the i. f. amplifier, the signal can be passed through the f. m. or the a. m. sections, depending on the positioning of the Function switch.

F.M. sections

From the i. f. amplifier, f. m. signals, as illustrated in Fig. 3.2 (a), are passed through three limiting stages to eliminate all amplitude changes and produce a rectangular waveform as shown in (b).

This limited i. f. waveform is passed to the pulse counter discriminator whose operation is illustrated in (c), (d) and (e). A pulse of fixed amplitude and width is generated every time the clipped i. f. signal passes through zero in the positive-going sense as shown in (b) and (c). At any given repetition frequency, these pulses have a constant mean amplitude, V_m , provided the pulse amplitude and width are fixed; thus when the p. r. f. varies due to f. m. of the input, the mean amplitude will also vary directly as the modulation frequency. This is illustrated in (c) and (d). In practice the limiter output is fed to a Schmitt trigger circuit, the resultant constant rise-time rectangular waveform being differentiated and used to drive a pulse generator. The pulses from here are later passed through a low-pass filter to remove all but the modulation frequency components.

The l. f. signal (e) is then amplified in the 1st l. f. amplifier, the gain of which can be standardized by the SET CAL-F. M. front panel preset in conjunction with the calibrator, and passed through the 150 kc/s low-pass filter and, if required to restrict the bandwidth to the audio range, through the 15 kc/s low-pass filter.

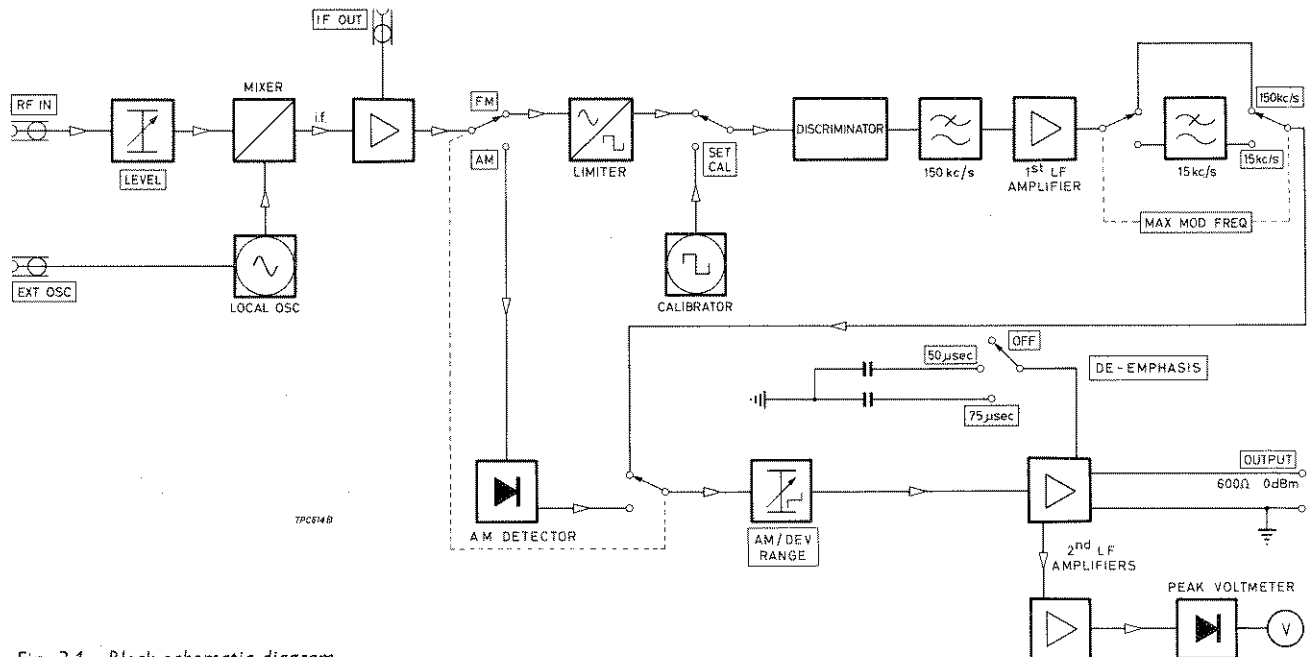

Fig. 3.1 Block schematic diagram

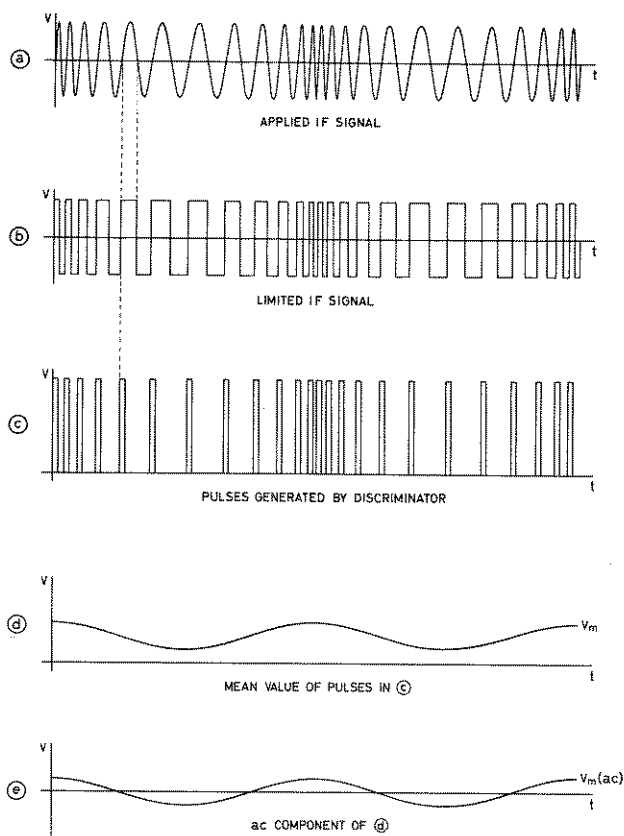

Fig. 3.2 Operation of discriminator

From this point onwards, all sections are common to f. m. and a. m. and it is necessary to return to the i. f. amplifier and consider the a. m. sections of the modulation meter before proceeding to describe these final sections.

A.M. sections

From the i. f. amplifier, a. m. signals are passed in the appropriate position of the Function switch to the a. m. detector. A diode detector is employed, preceded by an i. f. amplifier stage, the gain of which is variable by the SET A. M. control to standardize the carrier level at the detector. When the carrier level is correct, the d. c. output from the detector produces a reading at the SET line on the meter.

After detection, the signal is fed via a 50 kc/s low-pass filter to the A. M./DEV RANGE switch and other common a. m./f. m. sections.

The d. c. component of the detected a. m. signal is fed direct to the meter in the SET A. M.

and TUNE OSCILLATOR positions of the Function switch. In the former position the d. c. component, which is independent of a. m., is used as already stated to set the carrier level at the detector, while in the latter position, when the i. f. is fixed, it is used to set the mixer input to the correct level by adjustment of the LEVEL attenuator and also for oscillator peaking adjustment during initial setting up of the modulation meter.

A.M./F.M. sections

The A. M./DEV RANGE attenuator has a total attenuation of 40 dB switched in 10 dB steps and selects the deviation and modulation depth ranges on f. m. and a. m. On a. m., only the 10 and 20 dB steps are used.

After attenuation, the signals are passed to the 2nd l. f. amplifier which contains an output amplifier arranged to supply approximately 0 dBm into 600 Ω to the OUTPUT terminals. This stage effectively isolates the meter circuits from the OUTPUT terminals and permits de-emphasis networks to be switched in to the output terminals when required, without affecting the meter reading. The peak reading meter circuit consists of an amplifier with push-pull pair to operate the meter diode in its most linear region.

Calibration circuit

In the SET CAL position of the Function switch, the calibrator produces a standard crystal controlled deviation signal, i. e., it produces a similar signal to that from the limiter, with a peak-to-peak amplitude corresponding to a ± 200 kc/s deviation. For a more complete description of the calibrator, refer to section 3.8.

It thus provides a means of standardizing the discriminator and l. f. circuitry in order that accuracy can be maintained and also a means of checking for all possible sources of drift.

3.2 POWER UNIT (Unit A13—Fig. 7.6)

Occupying the rear corner behind the oscillator compartment, the power unit includes two power transistors fitted to heat sinks on the chassis, a printed board and electrolytic capacitors. One switch, SA, on the back panel selects the mains voltage range, and another, SB, the power source which may be mains or battery.

The mains input feeds straight into a low-pass filter, Z1, to prevent r. f. entering the instrument, then into a transformer T1, which has a double-wound primary. The transformer is astatically wound because of the susceptibility of the oscillator tuning system to magnetic fields. Its two primary halves are connected in series for 240 V, or parallel for 110 V, according to the position of switch SA. The secondary winding, centre tapped to earth, drives a full-wave rectifier whose output is smoothed by a conventional R-C network to give about 30 V. A series regulator follows the smoothing circuit, using the Zener diode MR5 for voltage reference. VT1, 2 and 3 form the error signal amplifier, feeding the base of the series regulator, VT6.

The output from this regulator is at -18 V, adjustable by preset potentiometer RV1, and supplies the a. m. detector, both amplifiers, the peak reading voltmeter, the discriminator and the -12 V regulator. Further isolation from mains voltage variations and hum is required for the remaining units. This is provided by the -12 V regulator, with VT4, 5 and 6 as the active elements and RV2 to set the level. The three transistors are, respectively, the error signal amplifier, emitter follower and series regulator. MR4 and VT4 are mounted in a heat sink to prevent rapid temperature differentials from affecting 12 V stability.

24 V applied to the BATTERY terminals (positive earth or isolated) passes through MR3, to avoid risk of damage through accidental polarity reversal, and goes to VT6 directly, when SB is in the BATTERY position.

3.3 MIXER (Unit A1—Fig. 7.2)

The mixer is a conventional, untuned, square law type, using a point contact silicon diode. It is built as a single, compact screened unit to keep spurious responses at a low level over the wide frequency range. Short signal paths are provided to allow operation near high intensity r. f. fields. The mixer is preceded by the r. f. attenuator which, at an input impedance of 50 Ω , gives 6 to 60 dB attenuation.

The r. f. input passes via the continuously variable attenuator, AT1, into the crystal mixer where mixing with the local oscillator takes place. The output from the mixer is at an i. f. of 1.5 Mc/s.

The normal input range is 4 Mc/s to 1000 Mc/s. R. F. inputs of over 1000 Mc/s can be used with reduced sensitivity. The useful upper limit is governed by oscillator stability and input sensitivity.

3.4 LOCAL OSCILLATOR (Unit A2a—Fig. 7.2)

VT1 produces 5.5 to 11 Mc/s directly for range 1 and 11 to 22 Mc/s second harmonic for range 2. Tuned by L1, one of the three variable inductors connected to the main tuning, the oscillator is evolved from the Colpitts circuit. There is no crystal control on this oscillator. C1 and L2 are provided to pre-adjust the range limits of frequency to the scale of the oscillator. VT1 is switched off by the switch SB on ranges 3-4 and 5-8.

Ranges 3 and 4 use VT2, tuned by L3, for the oscillator frequency, which is basically 22 to 44 Mc/s with 44 to 88 Mc/s second harmonic. The fundamental frequency is used for range 3, and the harmonic for range 4. This oscillator can be controlled by switching one of three crystals X1, 2, 3 into the circuit of VT2 in place of the de-coupling capacitor, L3 still needing to be tuned for maximum output.

Ranges 5 to 8 are derived from the 22 to 44 Mc/s oscillator, but the output goes to the multiplier board before it reaches the mixer.

Due to the permeability tuning employed in both oscillators, outputs cannot be taken from the inductor coils. The outputs are therefore taken by tapping the preset tuning capacitors, C1 and C14, by two capacitive matching systems - C4, 5 or C10, 11 in series. These outputs are fed via simple fixed attenuators to switch SB2B except in the case of VT2 on ranges 5-8, when it is fed via the doubler and harmonic generator board (A2b).

Doubler and harmonic generator (Unit A2b—Fig. 7.2)

VT1 is tuned, rather flatly, by L2 to act as a frequency doubler to the output from the oscillator VT2 (on A2a). L2 tunes over the range 44 to 88 Mc/s, and this signal is applied to the harmonic generator VT2 and VT3 (on A2b), whose output contains all the required harmonics of the oscillator fundamental.

3.5 I.F. AMPLIFIER (Unit A3—Fig. 7.2)

This board, in the narrow box alongside the local oscillator and power unit, contains three amplifying stages, each of two transistors, VT1 to VT6, the stages being coupled via band pass filters. No limiting occurs in the amplifier, and linearity, frequency response and an overall gain of 50 dB are stabilized by a negative feedback loop in each stage.

The output of the i. f. amplifier is taken in parallel paths to the Function switch, SB, and to the I. F. OUT socket via resistor R1 where it is available for viewing on an oscilloscope or for counting to check carrier frequency drift. Via SB1F, the output is routed to the a. m. detector or, in the f. m. positions, to the limiter.

3.6 LIMITER (Unit A4—Fig. 7.3)

Housed in the rear half of a compartment underneath the centre of the chassis, the limiter consists of three stages of emitter-coupled amplifiers, arranged so that signal amplitudes of either polarity above a certain level are limited. The emitters are connected to balancing potentiometers to equalize the excursion in each direction.

Part of the i. f. signal is tapped off from the third stage, differentiated by C7 and L1 and detected by MR1 to produce the uni-directional pulses shown in Fig. 3.3 (c). These pulses have

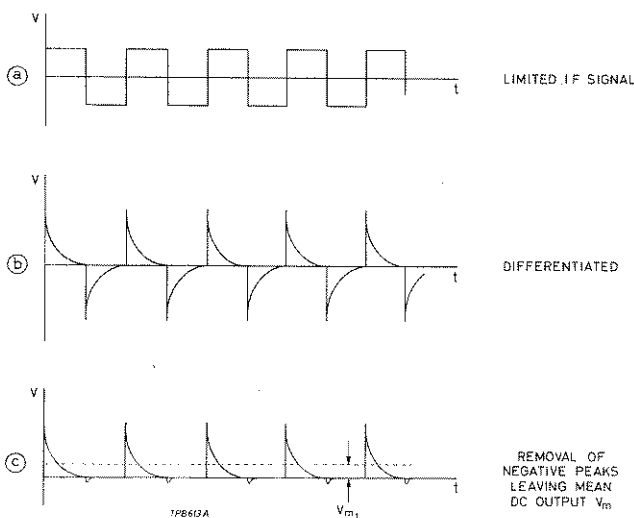

Fig. 3.3 Operation of limiter

a d. c. term, V_m , almost proportional to the repetition frequency. This d. c. is fed, in the SET FREQ positions of the Function switch, directly to the meter which is arranged to indicate SET when the i. f. is correct.

The presence of any appreciable degree of carrier shift when modulation is applied to the input signal will be indicated by the meter in the SET FREQ positions; the amount of shift may be measured with a counter at I. F. OUT provided that the gate time is long with respect to the period of the modulating signal or is equal to an integral number of periods.

3.7 DISCRIMINATOR (Unit A5—Fig. 7.3)

The pulse counter type discriminator occupies the front half of the central compartment fitted beneath the chassis, the rear half of this compartment being occupied by the limiter. The overall operation of the discriminator is described in section 3.1 and illustrated in Fig. 3.2 (c), (d) and (e).

The limiter output drives a Schmitt trigger circuit, VT2 and VT3, to produce a large square wave output into C4 with constant rise and fall times. The collector voltage of VT1, the trigger amplifier, is set by RV1 so that the Schmitt circuit is on the point of regeneration. *See section 3.1*

The square wave is differentiated and passed to a pulse generator, VT4 and VT5, which produces positive-going pulses. These pulses are clipped by VT6. The emitter of this semiconductor is taken to the -12 V line, so that it clips the bases of the positive-going pulses, thus maintaining constant amplitude.

VT7 is an emitter follower which, unlike VT6, is conducting continuously and presents a constant low impedance to the 150 kc/s low-pass filter. The low frequency change in the mean value of the pulses is therefore passed and the i. f. signal rejected.

3.8 CALIBRATOR (Unit A12—Fig. 7.5)

VT1 and VT2 form a multivibrator running at nominally 4 kc/s. C6, R8 and VT4 differentiate and clip the negative spikes of the square wave output from VT2 and feed them from a low impedance to the binary divider, VT7 and VT8.

Since the multivibrator runs at constant frequency, the positive-going pulses from VT4 are at equal time intervals. VT7 and VT8 divide these 4 kc/s pulses by two and produce an exactly 1:1 square wave output, via C11, at about 2 kc/s. VT5 and VT6 operate as a gating circuit controlled at 2 kc/s by this square wave.

VT3 is an oscillator accurately controlled at 400 kc/s by crystal XL1 and gated on and off by VT5 and VT6 at 2 kc/s. Thus the 400 kc/s signal is divided into bursts of r. f. at a repetition frequency of 2 kc/s and a 1:1 on/off ratio - see Fig. 3.4. This is fed to the discriminator via C9 when SB is at position SET CAL and corresponds, for calibration purposes, to a crystal controlled deviation of ± 200 kc/s. It should be noted that, in this mode, the 15 kc/s filter is always in circuit to reduce the tendency of high frequency ringing due to the use of a square wave for calibration.

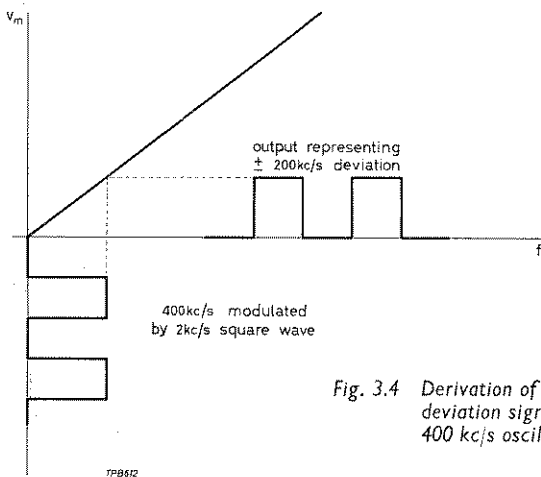

Fig. 3.4 Derivation of standard deviation signal from 400 kc/s oscillator

The calibrator operates only in the SET CAL position of the Function switch, being switched off at all other positions. A single attenuator pad contains the variable resistor AORV3 (see Fig. 7.1). This resistor (fitted immediately behind the calibrator board on the chassis) can be used to standardize the meter deflection to the SET mark.

3.9 LOW-PASS FILTERS (Units A6 and A8—Fig. 7.3)

150 kc/s and 15 kc/s

These filters are 3 dB down at 250 and 28 kc/s respectively to obtain optimum flatness over their pass bands of 150 and 15 kc/s. In order to accommodate the channel separation requirements of stereo broadcast monitoring, the filter designs

are such as to provide a linear phase frequency response.

The 150 kc/s filter integrates the pulses from the discriminator and rejects the i. f. signal; thus it produces a low frequency voltage which is proportional in amplitude to the deviation. The 15 kc/s filter restricts the bandwidth to the audio range and can be switched in as required by switch SE.

3.10 1st L.F. AMPLIFIER (Unit A7—Fig. 7.3)

Demodulated signals from the discriminator reach the first l. f. amplifier via the 150 kc/s low-pass filter. The amplifier has three stages, VT1 and 2 being a current feedback pair, while VT3 and 4 are arranged as a special low impedance configuration known as an 'emitter-squared follower'.

The amplifier has been designed to give high stability, large bandwidth and constant gain with immunity from h. t. changes, by virtue of its feedback loops. C6 carries positive feedback over part of the circuit to increase the gain, while R8 carries d. c. bias to the first stage. C5 and R7 take a. c. negative feedback to the first stage via the SET CAL F. M. control. The output stage, VT3 and VT4, gives a very low impedance, so that the output impedance of the amplifier is due almost entirely to R14. A high stability resistor is used here to give optimum matching to the following switched 15 kc/s filter. Similar considerations apply to the input stage, where the impedance is effectively lowered by parallel negative feedback, and R2 matches the preceding unit, the 150 kc/s low-pass filter.

Range attenuator (Chassis A0—Fig. 7.1)

Between the first and second l. f. amplifiers is the range attenuator. The 5 kc/s range is directly connected, but for each succeeding range 10 dB attenuation is switched into circuit. Two meter scales are used alternately to give 10 dB steps.

3.11 2nd L.F. AMPLIFIER (Unit A9—Fig. 7.4)

The action of VT1 and VT2 in this unit is similar to that of the first two transistors in the first l. f. amplifier. RV1 in the feedback loop sets the gain. Two connections are made after

VT2; from terminal 7 to the meter circuit, and from terminal 9 to the DE-EMPHASIS switch.

The remainder of the amplifier is the same as the first i. f. amplifier and its output is taken to the front panel terminals. Headphones may be used here, or a distortion factor meter, external meter (or oscilloscope). The output impedance is 600 Ω , and is isolated by C11. Do not allow d. c. to reach the OUTPUT terminals so as to avoid damaging C11, which is a low voltage electrolytic capacitor.

3.12 PEAK READING METER (Unit A10—Fig. 7.4)

For reading modulation depth and deviation, and for setting the f. m. calibration, the peak reading meter circuit is brought into use.

VT1 and 2 amplify the signal from the 2nd i. f. amplifier and RV1 presets the gain of the amplifier. The remainder of the circuit consists of two similar pairs of semiconductors arranged in push-pull, driving the meter via rectifier MR1. The polarity of the meter can be switched to read trough or peak on a. m., the positive or negative deviation on f. m. Feedback is used to stabilize the gain, reduce distortion and broaden the frequency response. The feedback loops include R3, R12, C14, R16, R19 and R24.

The meter is also used to measure the d. c. component of the output from the a. m. detector for i. f. level monitoring and tuning, and in the position SET FREQ it reads the voltage developed by a counter circuit in the limiter thus monitoring the frequency from the mixer for fine tuning purposes.

3.13 A.M. detector (Unit A11—Fig. 7.5)

The diode detector, MR1, is preceded by VT2 and VT3 which are arranged in a composite emitter follower configuration to give a large peak-to-peak signal without distortion, and thus allowing MR1 to operate over the linear part of its forward characteristic. The input to the detector is via a common-emitter amplifier, VT1, stabilized by negative feedback through R6 and R7.

MR1 is fed directly from a tuned circuit, C4 and L1, which is heavily damped by the low output impedance of VT3. This gives the cir-

cuit a wide band response which is flat to within the limits of the i. f. amplifier. MR1 feeds into a resistive load and a fraction of the voltage developed across the load is tapped off and fed to a 50 kc/s low-pass filter.

When the Function switch, SB, is in positions TROUGH or PEAK, the detected signal is fed via terminal 12 to the range switch, the 2nd i. f. amplifier and the meter circuit.

When making an a. m. measurement, the internal meter is switched directly to terminal 7 by the Function switch, SB, and the d. c. component adjusted by RV1, SET AM control, until the meter reads SET.

The d. c. component is also used for setting the input level to the i. f. amplifier, thus ensuring correct loading and good signal-to-noise ratio. On position TUNE OSCILLATOR AND ADJUST LEVEL of the Function switch, a fixed resistor, R1, is switched in place of RV1 and the correct level set up by adjusting the input attenuator until the meter indicates within the black arc.

3.14 BETWEEN-UNITS CIRCUITRY (Unit A0—Fig. 7.1)

The A. M./DEV RANGE switch, SC, controls three π pads of 10, 20 and 20 dB respectively. These attenuating pads are inserted in 10 dB steps as follows :

	Range	Attenuation
(1)	5 kc/s f. m.	0
(2)	15 kc/s f. m. , 30% a. m.	10 dB
(3)	50 kc/s f. m. , 100% a. m.	20 dB
(4)	150 kc/s f. m.	10 dB + 20 dB
(5)	500 kc/s f. m.	20 dB + 20 dB

It should be noted that the meter has two deviation scales; ranges 1, 3, 5 are associated with the bottom scale and the other ranges with the upper.

Also on the chassis is a single attenuator pad for the calibrator. This is switched in place of the range attenuator on the SET CAL position of the Function switch. This pad incorporates a variable resistor, RV3, which is mounted on the top of the chassis immediately to the rear of the calibrator board. RV3 standardizes the calibration circuit to the meter.

4.1 INTRODUCTION

This section contains information for keeping the equipment in good working order and for checking its overall performance.

CAUTION This instrument uses semiconductor devices which, although having inherent long term reliability and mechanical ruggedness, are susceptible to damage by overloading, reversed polarity and excessive heat or radiation. Avoid hazards such as reversal of batteries, prolonged soldering, strong r. f. fields or other forms of radiation, use of insulation testers or accidentally applied short circuits. Even the leakage current from an un-earthed soldering iron could cause trouble. Before shorting or breaking any circuit, refer to the circuit diagrams to establish the effect on bias arrangements of the transistors.

Screw fasteners

Screw threads used on this instrument are of the following sizes - 8BA, 6BA, 4BA, 2BA and 1/4 BSF.

Cruciform headed screws are of the Phillips Pozidriv pattern; to avoid damaging them a Pozidriv screwdriver should be used.

4.2 ACCESS AND LAYOUT

The main case assembly is held in position by the rear panel. This panel may be removed after unscrewing the four coin-slotted screws across the corners; the mains lead is held to the rear panel by a clip and will come away with it if the mains plug is withdrawn. The instrument can now be slid forward, out of the case; alternatively, it can be placed face-downwards on a soft surface and the case lifted off.

Rack-mounted models have top and bottom dust covers, each attached by four screws.

Figs. 4.1 and 4.2 show the general location of all units above and below the chassis. Compo-

nents may be identified by markings on the boards and chassis. For replacement of sub-assemblies and components, see Sects. 5.5 and 5.6.

4.3 PERFORMANCE CHECKS

The tests in this section may be used as a routine maintenance procedure to verify the main performance parameters of the instrument. All tests can be completed without removing the case, except where some internal readjustment is indicated. Tests may be done at any convenient frequency within the carrier range of the modulation meter provided that this frequency is also within the range of the test equipment items a, b, c, d and g.

4.3.1 Test equipment required

See Table 4.1.

4.3.2 R.F. input and i.f. output

Test equipment:- a, d, e and l.

This procedure verifies the sensitivity of the modulation meter and the adjustment of the local oscillator.

R.F. input resistance

- (1) Turn the LEVEL control mid-way. Connect the multimeter, set for resistance measurement, between the centre pin of the R. F. IN socket and earth and check that the reading is $50 \Omega \pm 10 \Omega$.

R.F. sensitivity

- (2) Adjust the signal generator to give a c. w. output of about 50 mV and connect it to the R. F. INPUT socket of the modulation meter and to the voltmeter, keeping the leads as short as possible.

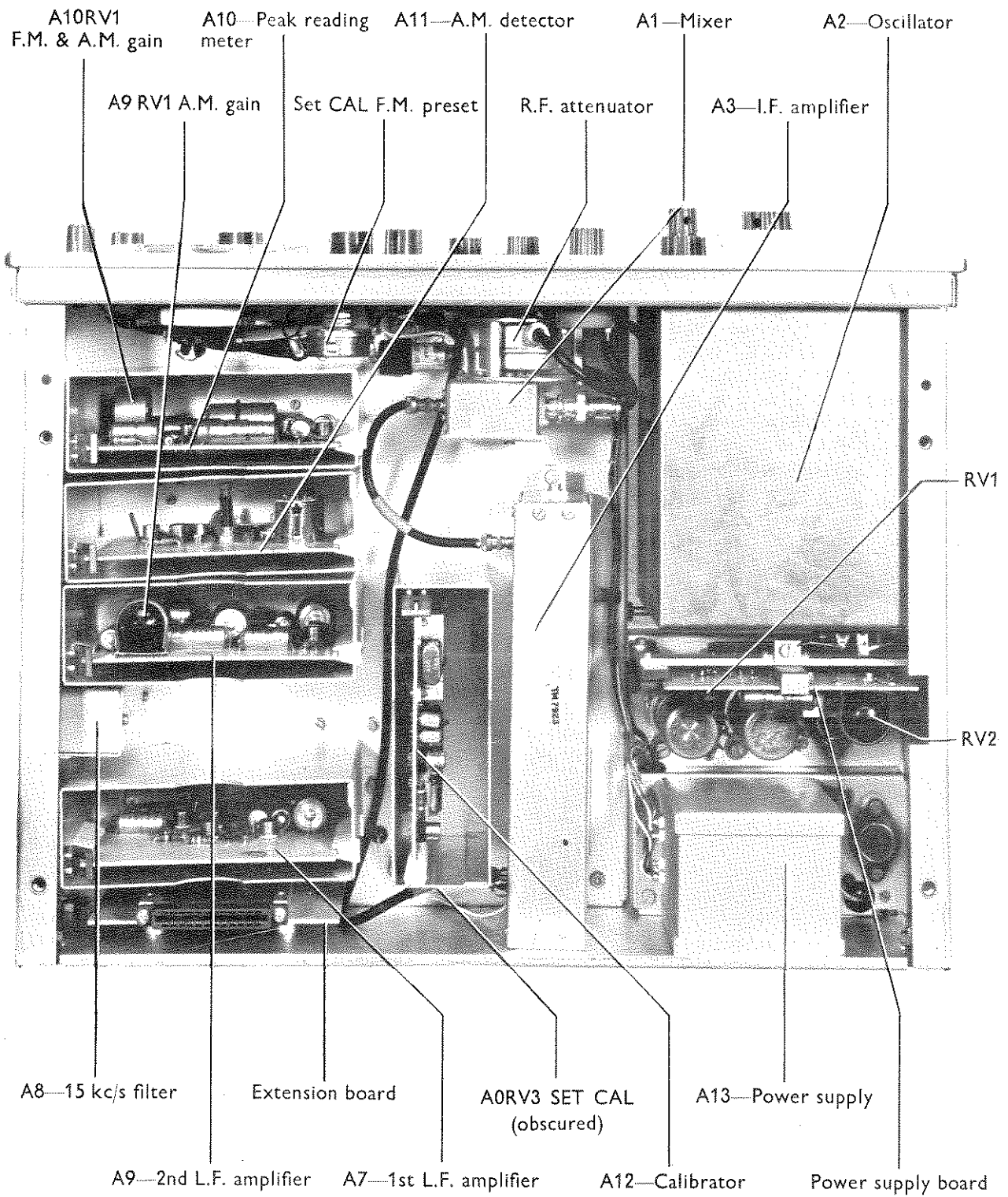

Fig. 4.1 Location of units (top)

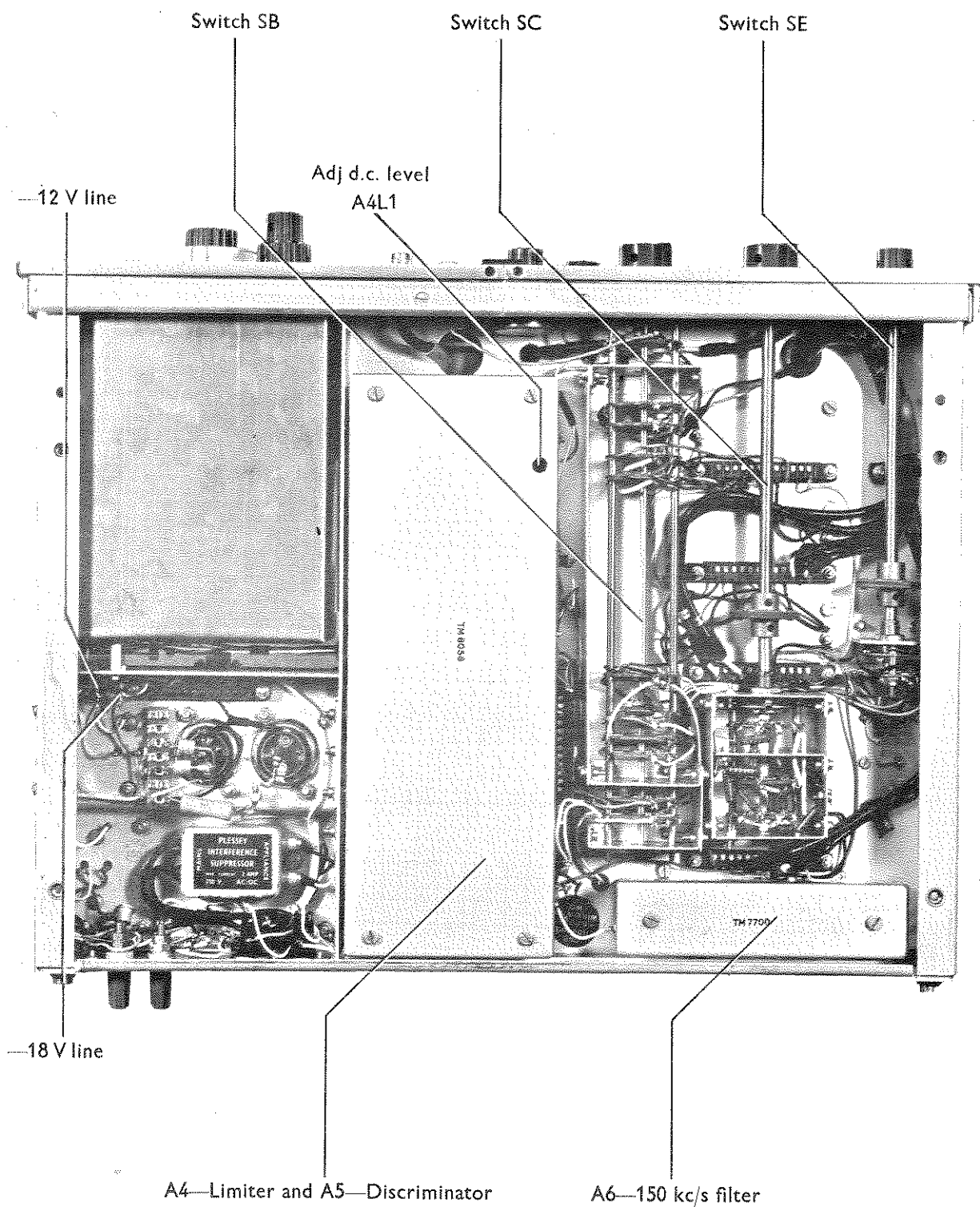

Fig. 4.2 Location of units (bottom)

TABLE 4.1

Item	Type	Minimum specification	Recommended model
a	A. M. signal generator	Output: 100 mV across 50 Ω A. M. : 80% Envelope distortion: 1% at 50% mod.	TF 867, TF 2002
b	F. M. signal generator	Deviation: 4 to 250 kc/s Mod. freq. : 0 to 150 kc/s Spurious a. m. : 1%	TF 995A/8M1
c	F. M. signal generator	Output: 200 mV across 50 Ω Deviation: 4 to 250 kc/s Mod. freq. : 0 to 150 kc/s	TF 1066B/6 (Mod. freq. : 40 c/s - 100 kc/s)
d	Electronic voltmeter	Sensitivity: 10 mV r. m. s. or average reading dB calibration	TF 2603
e	Frequency meter	Frequency: 20 kc/s to 1.5 Mc/s Sensitivity: 10 mV	TF 1417 with TF 2400 converter
f	L. F. oscillator	Frequency: 800 c/s to 56 kc/s Distortion: 0.5%	TF 1101 (quantity 2)
g	Spectrum analyser	Resolution: 60 dB at 50 c/s	OA 1094 (up to 30 Mc/s)
h	Oscilloscope	L. F. general purpose	TF 2203
i	Selective level meter	Frequency: 1.4 to 1.6 Mc/s	Siemens Pegelmesser
j	Crystal oscillator	Same frequency and output as item b in test 4.3.5	-
k	Low-pass filter	Cut-off frequency: 15 kc/s	See Sect. 2.9
l	Multimeter	To measure resistance, 40 to 60 Ω	Avometer Model 8
m	Amplitude modulator	A. M. depth: 80%	TF 1102

- (3) On the modulation meter, turn the oscillator RANGE switch and TUNE control to suit the r. f. input frequency, the Function switch to TUNE OSCILLATOR AND ADJUST LEVEL and the LEVEL control fully clockwise. meter deflection is at the bottom of the black arc.
- (4) Tune for peak meter deflection and then adjust the signal generator output until the
- (5) Check that the signal generator output, as indicated on the voltmeter, is within the figure given for r. f. input sensitivity in Sect. 1.2 - Data Summary. If not, check the harmonic generator alignment as in Sect. 5.4.5 and/or the output of the oscillator.

I.F. output and frequency

- (6) Connect the frequency meter and voltmeter to the I. F. OUT socket and check that the i.f. is approx. 200 mV (with the meter reading at the bottom of the black arc) and remains within 10% of 1.5 Mc/s when the modulation depth of the input signal is varied from 0 to 80%. (Keep the leads as short as possible.) If the frequency is in error see Sect. 5.4.10.

I.F. output impedance

- (7) Adjust the LEVEL control to increase the voltage at the I. F. OUT socket to 700 mV. Connect a 10 kΩ ±2% resistor across the voltmeter input and check that reading drops to between 310 and 400 mV.

4.3.3 F.M. deviation accuracy

Test equipment:- b, d, e and g.

The internal f.m. calibrator provides a standard of good long-term stability for checking and resetting the deviation reading accuracy as described in Section 2.5 (8). The calibrator accuracy is largely dependent on the frequency of its 200 kc/s oscillator crystal, which is unlikely to change significantly. If the calibrator accuracy is suspected, the deviation reading should be checked by making a normal measurement on a symmetrically modulated signal of accurately known deviation set up by the Bessel Zero method described below.

- (1) Connect the signal generator, externally modulated by the l.f. oscillator, to the inputs of the modulation meter and the spectrum analyser, as shown in Fig. 4.3.

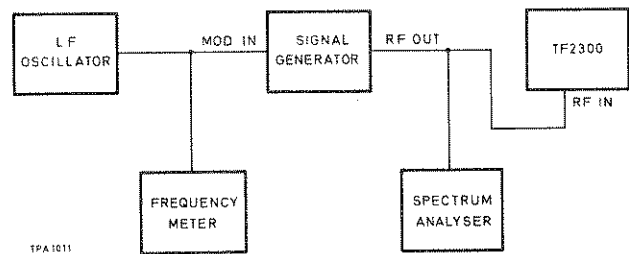

Fig. 4.3 Bessel zero measurement

- (2) Adjust the oscillator frequency, checked against the frequency meter, to 26.27 kc/s. Slowly increase the signal generator deviation from zero until the carrier component, viewed on the spectrum analyser, disappears for the second time. This occurs at a deviation ratio of 5.52, which means that the deviation is 145 kc/s. (The MAX MOD FREQUENCY should be 150 kc/s.)
- (3) Set up the modulation meter to measure this signal as described in Sect. 2.5, using the 150 kc/s DEV RANGE.
- (4) If the modulation meter reading differs from 145 kc/s when switched to either DEV+ or DEV-, adjust the SET CAL F.M. preset to give the best compromise accuracy between the two measurements. Then turn the

TABLE 4.2

DEV RANGE kc/s	MAX MOD FREQ range kc/s	Deviation kc/s	Modulating frequency kc/s	Carrier disappearance	Modulation Indices
500	150	480	55.46	3	8.6537
	150	360.7	150	1	2.4048
	150	145	26.27	2	5.5201
150	150	145	26.27	2	
	15	48	8.696	2	
50	15	48	8.696	2	
	15	14.5	2.627	2	
15	15	14.5	2.627	2	
	15	4.8	0.8696	2	
5	15	4.8	0.8696	2	

Function switch to SET CAL and, without disturbing the SET CAL F. M. preset, bring the meter reading to the SET mark by adjusting the internal f. m. preset, A0RV3 - see Fig. 4.1. If this has insufficient range select a new value for resistor A0R15.

- (5) This check can also be made at other deviations as shown in Table 4.2.
- (6) If the deviation errors show a general trend in one direction the presets RV3, RV5 and RV4 should be adjusted to give the best compromise on their respective ranges. As RV3 affects all ranges it should be adjusted first.

Preset	Adjust for best compromise on deviation range (kc/s)
RV3	5, 15, 50
RV4	500
RV5	150

(RV3 will be usually found to give the best compromise by adjusting on the 5 kc/s deviation range.)

4.3.4 A.M. depth accuracy

Test equipment:- a, f and i.

A. M. depth accuracy, unlike f. m. deviation, cannot be checked against an internal calibrating circuit. Therefore, the a. m. measurement accuracy can only be checked by making a normal measurement on a signal of accurately known modulation depth. A depth of about 50% is recommended. It is important that this signal should have a very low envelope distortion as this can cause an apparent error in depth indication.

The modulation depth can be checked by means of a selective level meter as follows:-

- (1) Set the l. f. oscillator frequency to 3 kc/s and use it to modulate the signal generator to a depth of nominally 50%.
- (2) Set up the modulation meter for measuring this signal as described in Sect. 2.6.

- (3) Connect the selective level meter to the I. F. OUT socket of the modulation meter, tune the level meter to the carrier frequency of 1.5 Mc/s and set its gain to give a 0 dB reference level.
- (4) Retune the level meter to one of the 3 kc/s sidebands and adjust the l. f. oscillator output to give a level meter reading of 12 dB below the reference level. If the sideband levels are different, adjust for a mean reading of 12 dB. This corresponds to a modulation depth of 50%.
- (5) If the modulation meter reading differs from 50% when switched to either PEAK or TROUGH, adjust the internal preset A9RV1 for the best compromise accuracy between the two readings.

Note: Adjustment of RV1 may affect the accuracy of the f. m. deviation reading; therefore, after adjusting RV1, reset the f. m. calibration as shown in Sect. 2.5 (8) (not by adjusting the internal preset).

- (6) This check can also be made at other modulation depths, as shown in the following table, in order to optimize reading errors.

TABLE 4.3

A.M. RANGE %	Modulation	Sideband amplitude, dB
100	90	-6.94
100	80	-7.96
100	70	-9.12
100	60	-10.46
100	50	-12.04
100	40	-14.02
30	30	-16.52
30	20	-20.00
30	10	-26.02

The higher modulation depths are not recommended unless an unusually low envelope distortion can be achieved.

4.3.5 F.M noise

Test equipment:- b, d, h, j and k.

This is measured by comparing the output of the modulation meter when 5 kc/s deviation is applied with the output when deviation is zero.

Fig. 4.4 F.M. noise measurement

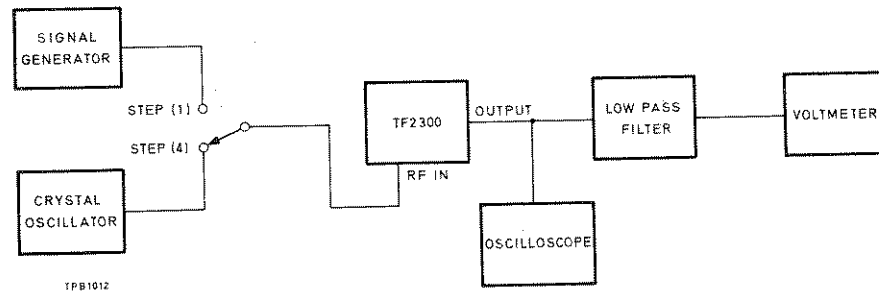

To ensure that the latter output is due to the modulation meter alone it is important that the source should be exceptionally free from spurious noise deviation.

- (1) Apply an f.m. input with 5 kc/s deviation from the signal generator. Connect the oscilloscope, filter and voltmeter to the OUTPUT terminals as shown in Fig. 4.4.
- (2) Set the modulation meter for deviation measurement as in Sect. 2.5, with the local oscillator crystal-controlled (see Sect. 2.15). Switch the DEV RANGE to 5 kc/s and the MAX MOD FREQ to 15 kc/s.
- (3) Note the reading on the voltmeter - this should be about 0 dBm if the modulation meter is terminated in 600 Ω.
- (4) Replace the signal generator with the external crystal oscillator set to the same output level and note the reduction in voltmeter reading. This should be at least 50 dB, which is equivalent to a noise level of -70 dB with reference to 50 kc/s deviation in a 15 kc/s bandwidth.
- (5) Note that the oscilloscope trace is free from hum, external field and noise. If not, check the power supply ripple - see Sect. 5.4.3.

4.3.6 F.M. distortion

Test equipment:- b, c, 2f and i.

- (1) Set up the equipment as shown in Fig. 4.5. Adjust c to give a c.w. output of 200 mV at any convenient frequency F_{c1} . Adjust b to give a c.w. output of 50 mV at frequency ($F_{c1} - 1.5$ Mc/s).

- (2) On the modulation meter set the Function switch to TUNE and the oscillator RANGE switch to EXT. Adjust the frequency of c for maximum reading on the TF 2300 meter and adjust the TF 2300 LEVEL control for a reading within the black arc.

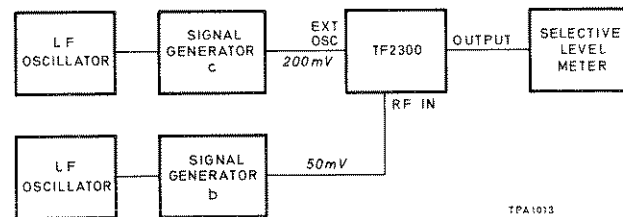

Fig. 4.5 F.M. distortion measurement

- (3) Switch to F.M. SET FREQ and adjust c frequency to bring the TF 2300 meter reading to the SET mark.
- (4) Switch to DEV+ and turn the MAX MOD FREQ switch to 15 kc/s and the DEV RANGE switch to 150 kc/s.

Apply external modulation to the two signal generators as follows:

TABLE 4.4

Sig. gen.	Mod. freq.	Deviation
c	16 kc/s (f1)	37.5 kc/s
b	14 kc/s (f2)	37.5 kc/s

Switch off b and set up the level meter to give a reference level of -6 dB at 150 kc/s. Switch on b again.

Measure the levels of the following components:-

2nd harmonic: $(f_1 - f_2)$: 2 kc/s

3rd harmonic: $(2f_2 - f_1)$: 12 kc/s

and express them in dB's relative to 0 dB. Add +6 dB to the 2nd harmonic reading and +9 dB to the 3rd harmonic reading. The r. m. s. sum of the two levels (see below for method of calculation) should be lower than -54 dB (3%). Distortion limits for other values of deviation and modulation frequency are given in Sect. 1.2 - Data Summary.

Summation of dB levels

The r. m. s. sum of two dB levels can be obtained by increasing the level of the larger one by an increment between 0 and 3 dB; the value of increment depends on the difference between the two levels as shown by the graph. For example, if the two levels are -40 dB and -46 dB, giving a difference of 6 dB, the increment is 1 dB; the sum of the two levels is therefore $-40 + 1$ dB = -39 dB.

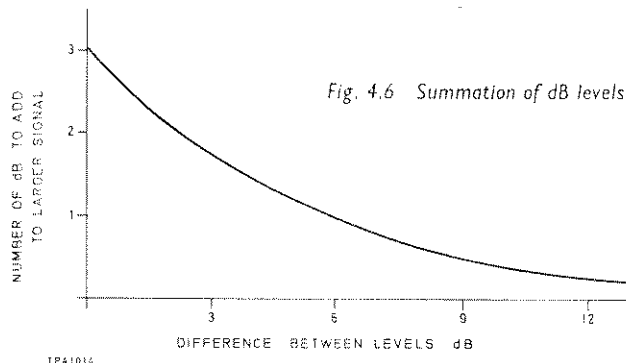

4.3.7 A.M. rejection

Test equipment:- a, f and m.

- (1) Set up the equipment as shown in Fig. 4.7. Adjust the signal generator to give a c. w. output of 100 mV at any convenient frequency. Adjust the l. f. oscillator frequency to 1 kc/s at a level which gives 80% modulation as measured on the TF 2300.
- (2) On the TF 2300 set the Function switch to TUNE and the OSCILLATOR TUNE control to give maximum meter reading. Then adjust the LEVEL control for a reading within the black arc.
- (3) Switch to F. M. - SET FREQ and adjust the

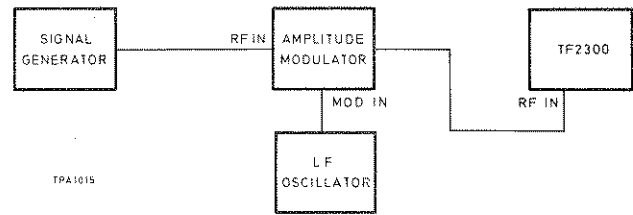

Fig. 4.7 A.M. rejection measurement

OSCILLATOR tune control to bring the meter reading to the SET mark.

- (4) Switch to TUNE and adjust the LEVEL control to give a reading just below full-scale on the black arc.
- (5) Turn the DEV RANGE switch to 5 kc/s and the MAX MOD FREQ switch to 15 kc/s.
- (6) Switch to DEV+ and DEV- in turn and check that the residual reading on the meter is less than 750 c/s.

4.4 CLEANING AND LUBRICATING

Rotary switch contacts

These should be cleaned once or twice a year, depending on usage, with benzine or white spirit (not carbon tetrachloride). After cleaning wipe the contacts with a suitable lubricant such as a 1% solution of petroleum jelly in white spirit.

Oscillator unit

Excessive lubrication must be avoided but the moving parts should be cleaned and lubricated at least twice a year:

- (a) Worm shaft: Use Rocol anti-scuffing paste.
- (b) Carriage slide: Use Aeroshell 4 oil.
- (c) Scale drum mounting: Apply a few drops of Aeroshell 4 oil to the felt washer on the spigot mounting.
- (d) Range switch bevel gears: Use Rocol anti-scuffing paste.

Note: Sealed bearings at end of worm shaft will not require lubrication within the life of the instrument.

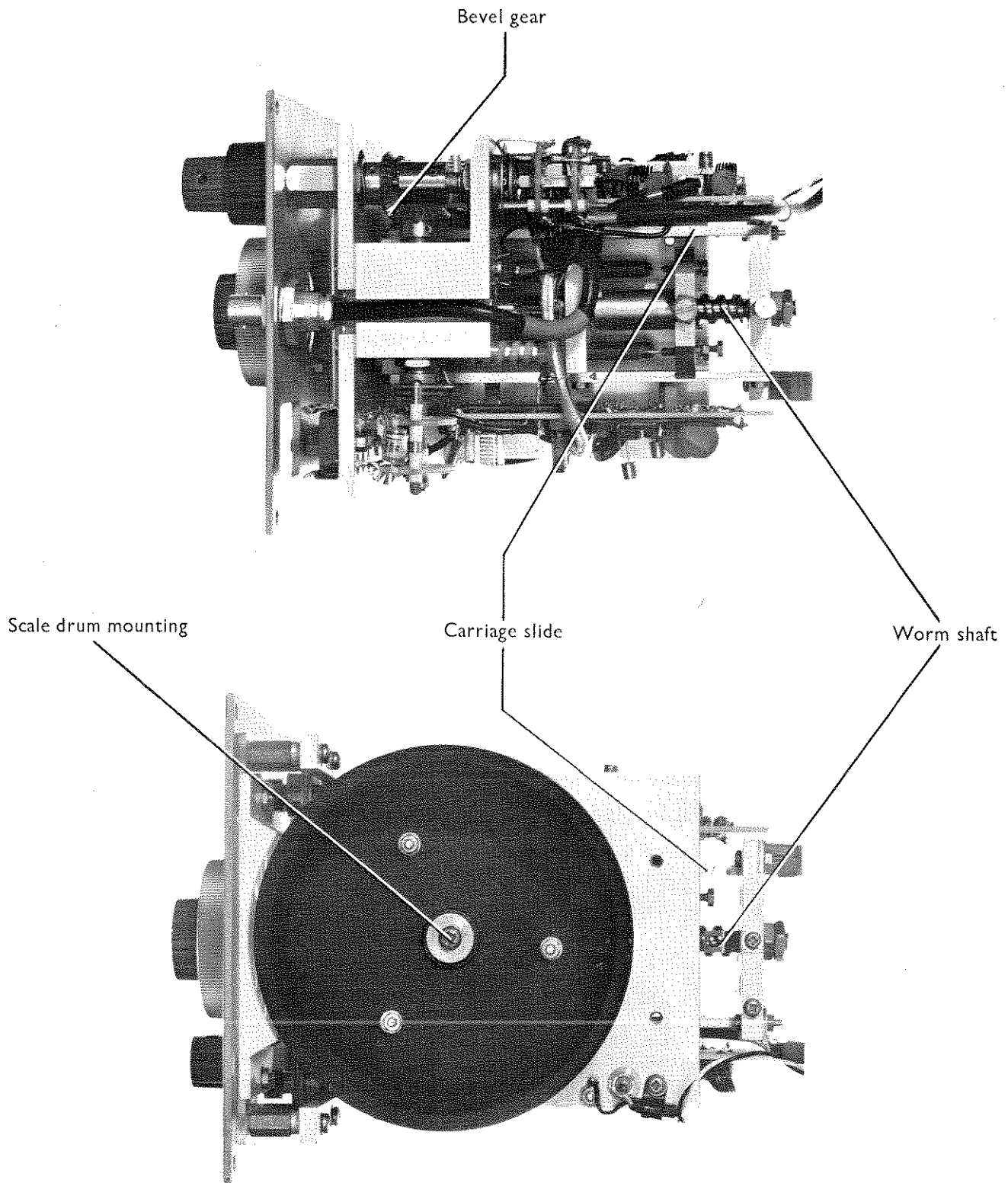

Fig. 4.8 Oscillator lubrication points

5.1 INTRODUCTION

This chapter contains information for the localization and repair of faults. Performance limits quoted are for guidance only and should not be taken as guaranteed performance specifications unless they are also quoted in the Data Summary section.

CAUTION See Maintenance, Sect. 4.1, for precautions in handling semiconductors and for advice on screw fasteners.

In the case of any difficulty, please write to or phone the Marconi Instruments Service Division (see address on back cover) or nearest representative, quoting the type and serial number on the data plate at the rear of the instrument. If the instrument is being returned for repair, please indicate clearly the nature of the fault or the work you require to be done.

5.2 FAULT LOCATION

General procedure

Methodical fault location can be performed at the following three levels:

- (i) Front panel functional checks for general localization of a fault - see Sect. 5.2.2.
- (ii) Internal checks for more detailed localization - see Sect. 5.2.3.
- (iii) Systematic calibration, which can be used to locate a fault for which methods (i) and (ii) are inadequate - see Sect. 5.4.

5.2.1 Test equipment required

See Table 5.1.

5.2.2 Front panel checks

As a first step in fault finding, the three following tests will help you to verify nearly all the circuits of the modulation meter and to localize the fault to certain areas. These tests can be performed without removing the cover. Failure of all three tests may indicate a faulty power supply, in which case first check the fuses on the rear panel.

- (1) Turn the Function switch to SET CAL. If the meter reads SET, the calibrator (A12) and the discriminator, 1st and 2nd l.f. amplifier, peak reading voltmeter and associated circuits (A5 to A10) are working. If there is no meter indication, but the 2 kc/s calibrator square wave can be seen with an oscilloscope at the OUTPUT terminals, then the peak reading voltmeter circuit, (A10), is faulty.
- (2) Turn the Function switch to TUNE OSCILLATOR AND ADJUST LEVEL. Connect a signal to the R. F. IN socket and check that, by adjusting the

TABLE 5.1

Item	Type	Minimum specification	Recommended model
a	Signal generator	Frequency: 1.5 Mc/s and between 4 and 1000 Mc/s Output: c. w., up to 100 mV.	TF 144, TF 995 or TF 2002, TF 1066
b	Multimeter	20 V d. c. at 20 k Ω /V 250 V a. c.	Avometer model 8
c	Measuring oscilloscope	Bandwidth: 5 Mc/s Sensitivity: 20 mV/cm	M.I. TF 2201 series with TM 6970A plug in

OSCILLATOR TUNE and LEVEL controls, a meter deflection in the black arc can be obtained. If so, the local oscillator, mixer and i. f. amplifier (A1 to A3), most of the a. m. detector (A11) and the peak reading voltmeter (A10) are working.

If not, but the meter deflects when the input frequency is changed to the i. f. of 1.5 Mc/s, then the local oscillator or mixer are suspect. A fault in the local oscillator can be confirmed if the first paragraph of test 2 gives a positive result when using an external local oscillator.

- (3) Turn the Function switch to F. M. SET FREQ. or A.M. SET FREQ. (after setting up the meter deflection as in step 2 above). Check that the meter deflects to the SET mark when the OSCILLATOR TUNE control is slightly readjusted. If so, the limiter circuit (A4) is working.

Input attenuator

This can be checked by feeding a 1.5 Mc/s signal into the EXT OSC socket when the sensitivity should be approximately 20 mV input for a meter reading on the bottom of the black arc when the function switch is set to TUNE. If a 5 mV signal is now applied to the R. F. INPUT socket a meter reading will be produced again on the black arc.

If there is no deflection when the 20 mV signal is applied to the EXT OSC socket the attenuator or part of the mixer is faulty. It is more likely to be the attenuator.

5.2.3 Internal checks

Having roughly localized the fault by the front-panel tests it may be more accurately located by signal tracing tests, using the inter-unit wiring diagram as a guide.

- (1) First check the power supply unit output voltages at A13C9 (-18 V) and C12 (-12 V) - see Fig. 4.2 for location. If incorrect, reset as described in Sect. 5.4.3. If the fuses are intact and there is no output from the power supply unit when a. c. operated, try changing to battery operation. If this restores the output, a faulty transformer/-rectifier circuit is indicated.

- (2) If trouble is suspected between the calibrator unit and the meter, turn the Function switch to SET CAL and check the calibrator waveforms from the calibrator unit output to the meter. These should be as shown in Sect. 5.3, although the frequency of the square wave modulation is not critical and may differ from the nominal 2 kc/s value illustrated.

Having identified a faulty board, use the static voltage information on the circuit diagrams as a guide to locating the source of the trouble.

5.3 WAVEFORMS

The oscillograms illustrated in Fig. 5.1 show the significant waveforms that occur between the output of the calibrator unit (A12) and the OUTPUT terminals. The measuring points are indicated on the inter-unit wiring diagram, Fig. 7.1, and the circuit diagrams.

Measurement should be made with an oscilloscope of at least 5 Mc/s bandwidth and 20 mV/cm sensitivity, such as M.I. type TF 2201 series. Contact with the printed board edge connectors may be made from below the chassis but, if more convenient, the Extension Board TM 7926 may be used to allow access from above the chassis.

5.4 REALIGNMENT

5.4.1 Introduction

This is a complete realignment procedure with the steps arranged in a logical order. If the full procedure is not required, for example following a component replacement, individual steps may be performed providing they do not interact with other adjustments. Although the likelihood of such interaction is pointed out wherever possible, it is recommended that you always consider the effects of any readjustment by reference to the circuit diagrams.

NOTE: Performance limits given in this section are for guidance only and should not be taken as guaranteed performance specifications unless they are also quoted in the Data Summary section.

5.4.2 Test equipment required - see Table 5.2.

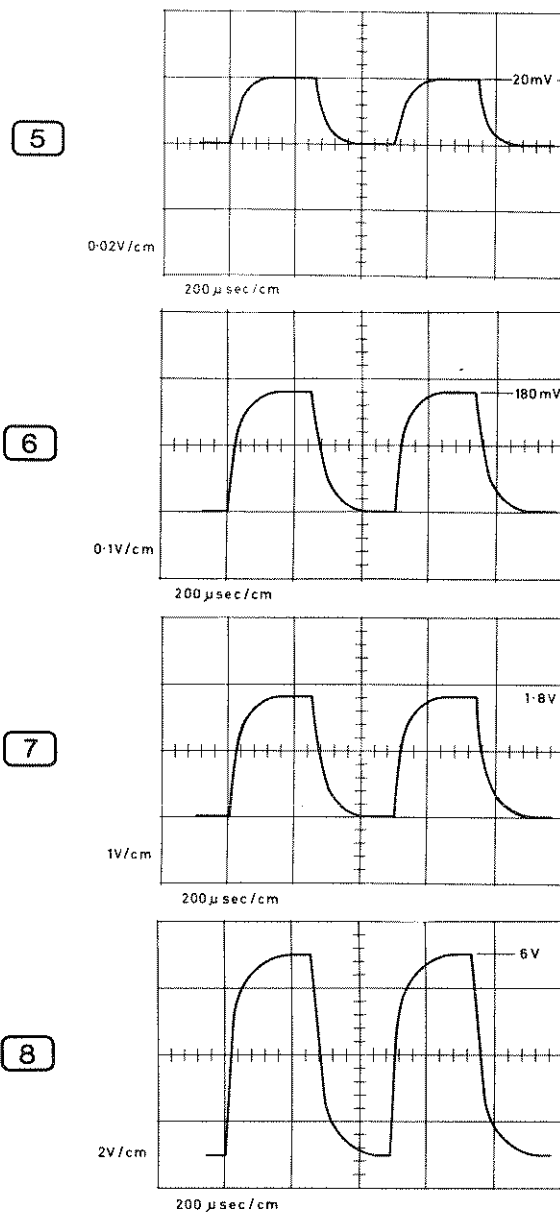
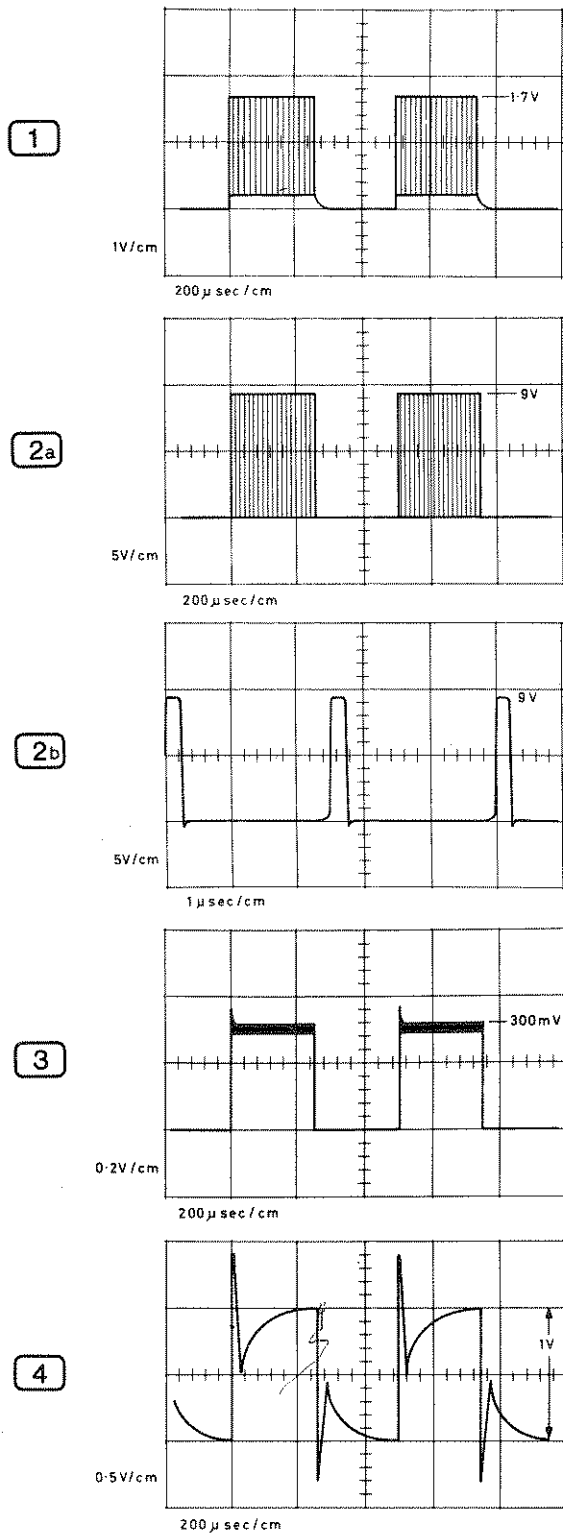

Location of waveforms

1	pin 12	A12	Calibrator
2a	pin 4	A5	Discriminator
2b	pin 4	A5	Discriminator
3	pin 1	A7	1st l. f. amplifier
4	pin 12	A7	1st l. f. amplifier
5	pin 1	A9	2nd l. f. amplifier
6	pin 7	A9	2nd l. f. amplifier
7	—	—	OUTPUT socket
8	{ pin 4 pin 12 (inverted) }	A10	Peak reading voltmeter

The conditions to obtain these waveforms are as follows:

DE-EMPHASIS switch to OFF. Function switch to SET CAL.

Fig. 5.1 Oscilloscopes

TABLE 5.2

Item	Type	Minimum specification	Recommended model
a	Multimeter	Range: 0 - 20 V d. c. 0 - 270 V a. c.	Avometer Model 8
b	Variable mains transformer	Range: 190 - 260 or 90 - 160 V a. c.	Variac
c	Wave analyser	Range: 50 - 200 c/s Sensitivity: 50 μ V	TF 2330
d	Differential voltmeter	Discrimination: 1 mV in 18 V	TF 1377, TF 2606
e	Frequency meter	Range: f*	TF 1417 with Converter TF 2400
f	R. F. millivoltmeter	Range: f*	TF 2603
g	T connector	BNC-BNC-BNC	
h	Crystals	Frequencies: 22, 33 and 44 Mc/s	
i	Response analyser	4 to 1000 Mc/s	Rhode & Schwarz 'Polyskop' SWOB II
j	Signal source	Range: 100 c/s - 23 kc/s	TF 2001 with standardized attenuator
k	Sensitive voltmeter	Range: 100 c/s - 23 kc/s with dB calibration	TF 2600
l	Crystal oscillator	Frequency: 1.5 Mc/s	
m	Capacitor	0.014 μ F	
n	R. M. S. voltmeter	Frequency: 30 c/s - 150 kc/s Sensitivity: 1 mV full-scale	
o	Oscilloscope	Sensitivity: 10 mV/cm	TF 2200 series with TM 6455 plug-in

f*; range to suit user's requirements within coverage of TF 2300 (4 to 1000 Mc/s); TF 1417 etc. and TF 2603 will meet most of these.

5.4.3 Power supply

Test equipment:- a, b, c and d

- (1) Measure the output of the -18 V and -12 V regulated supplies at the points illustrated in Fig. 5.2.

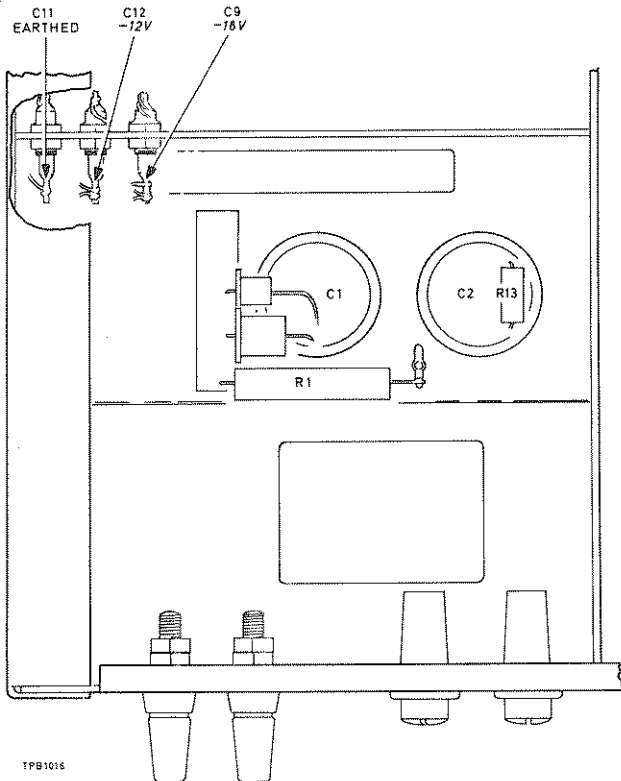

Fig. 5.2 Regulated supply measuring points

If the voltages are not within $\pm 1\%$ of nominal, adjust RV1 for -18 V or RV2 for -12 V.

The location of these potentiometers is illustrated in Fig. 4.1.

- (2) Connect the wave analyser to the -18 V line and check that the 50 c/s, 100 c/s and 150 c/s ripple components are each less than $100 \mu\text{V}$. Check that the same components on the -12 V line are each less than $50 \mu\text{V}$.
- (3) Replace the wave analyser with the differential voltmeter. Check that the -18 V line voltage does not change by more than $\pm 20 \text{ mV}$ when the a. c. supply is varied from 190 to 260 V, (or 95 to 130 V). The change on the

-12 V line should be not more than $\pm 2 \text{ mV}$, and preferably about $\pm 1 \text{ mV}$.

5.4.4 Local oscillator

Test equipment:- e, f, g and h

- (1) Connect the frequency meter and millivoltmeter via a T-connector to the output plug of the oscillator, PLB. Turn the LEVEL control fully clockwise.
- (2) Switch to oscillator RANGE 1-2, tune through the range and check that the dial calibration is within $\pm 3\%$ of the frequency meter reading and that the level is between 0.5 V and 1 V. If the calibration accuracy is outside limits, withdraw the local oscillator unit and reset range trimmer L2 for optimum accuracy at the low frequency end and/or C1 at the high frequency end. Replace the local oscillator unit and recheck the calibration.
- (3) Switch to oscillator RANGE 3-4, tune through the range and check that the dial calibration is within $\pm 3\%$ of the frequency meter reading and that the level is between 0.6 V and 0.8 V. If the calibration accuracy is outside limits withdraw the local oscillator unit and reset range trimmer L4 for optimum accuracy at the low frequency end and/or C14 at the high frequency end. Replace the local oscillator unit and recheck the calibration.
- (4) Switch to oscillator RANGE 3-4 and turn the CRYSTAL switch to position 1. Insert a 22 Mc/s crystal into socket 1 and check that the frequency meter reads within $22 \text{ Mc/s} \pm$ the crystal tolerance after tuning the Local Oscillator to 22 Mc/s.

5.4.5 Harmonic generator

Test equipment:- i.

- (1) Shunt the resistor in series with the I. F. OUT socket by a $1 \text{ k}\Omega$ resistor.
- (2) Connect the I. F. OUT socket to the R. F. Input of the Polyskop and the R. F. IN socket to the R. F. Output of the Polyskop.
- (3) Set the Polyskop controls as follows:

Output Attenuator: 30 or 40 dB.
 Sweep Width control: maximum sweep.
 Centre Frequency control: mid-way.
 Y1 Gain control: maximum gain.
 Y1 switch: B.
 Y2 switch: off.

Set the TF 2300 controls as follows:

SUPPLY: on.
 Oscillator RANGE: RANGE 5 - 8.
 CRYSTAL: OFF

- (4) Adjust the OSCILLATOR TUNE control to about 88 Mc/s on the tuning scale, i.e. a local oscillator frequency of 22 Mc/s.
- (5) Set the Frequency switch on the Polyskop to about 50-100 Mc/s and the Frequency Markers switch to 50 Mc/s.

The Polyskop screen will show a sweep between 50 and 100 Mc/s with the 50 Mc/s marker pips at each end of the trace.

The 88 Mc/s signal, i.e. 4th harmonic of the 22 Mc/s from local oscillator, will show as a double blip at 88 Mc/s on the trace. Tune the local oscillator over the frequency band, i.e. increase frequency and the frequency blip on the Polyskop should move towards the 100 Mc/s marker.

Range 5 on the TF 2300 covers 88-176 Mc/s; therefore, when the 100 Mc/s blip reaches the 100 Mc/s marker, change the Frequency switch on the Polyskop to 100-200 Mc/s and the 100 Mc/s blip will appear superimposed on the 100 Mc/s marker at the beginning of the trace. Continue to tune through the range to 176 Mc/s.

- (6) Then tune the local oscillator through the remaining frequency ranges up to 1000 Mc/s and note the frequencies at which the frequency blip shown on the Polyskop is a minimum and measure the sensitivity at these points using the signal generator and the R. F. millivoltmeter.

NOTE: When using the Polyskop above 400 Mc/s, the variable frequency control must be set to the required frequency and the OSCILLATOR TUNE control on the TF 2300 should be tuned to this

frequency; the frequency blip will then be shown on the Polyskop. It is advisable to adjust the Polyskop frequency control and the OSCILLATOR TUNE control together, so that the correct frequency blip remains on the screen.

- (7) If the sensitivity at any min is below that specified, adjust capacitor A2bC7 and the position of the tuning slug in coil A2bL2 to increase the amplitude where the frequency blip is a minimum. It may also be necessary to select a new value for A2bC14.

NOTE: Capacitors C7 and C14 will need to be set to a compromise position to give the best sensitivity throughout the frequency range, as there will be more than one minimum sensitivity point. Sensitivity becomes approximately correct if the input attenuator on the Polyskop can be set to the 30 or 40 dB position. While the checks are being carried out, note that no spurious oscillations occur.

5.4.6 De-emphasis

Test equipment: j and k

- (1) With the modulation meter switched off, disconnect the yellow lead from the discriminator unit output (A5, pin 4) and connect the lead to the output of the signal source.

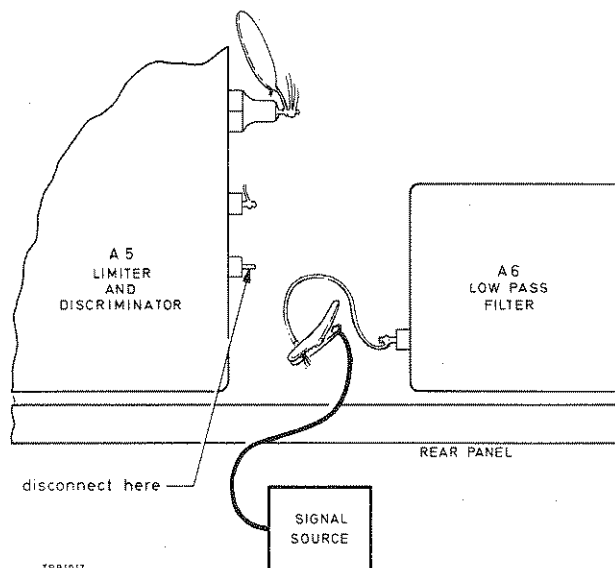

Fig. 5.3 Location of discriminator output lead

- (2) Connect the voltmeter to the OUTPUT terminals.
- (3) Turn the DE-EMPHASIS switch to 75 μ sec, the Function switch to DEV+ and the MAX MOD FREQ to 150 kc/s.
- (4) Set the signal source frequency to 100 c/s and adjust its output level to give a suitable reference deflection on the output voltmeter.
- (5) Vary the signal source frequency, keeping the output level constant, and check that the response relative to the 100 c/s reference is within ± 1 dB of:

-3 dB at 2.1 kc/s.
-16.9 dB at 15 kc/s.

- (6) Repeat step (5) with the DE-EMPHASIS switch set to 50 μ sec and check that the response is within ± 1 dB of:

-3 dB at 3.15 kc/s.
-16.9 dB at 22.5 kc/s.

5.4.7 Range attenuator

Test equipment: j and k

- (1) Connect the signal source as in step (1) of Sect. 5.4.6.
- (2) Connect the voltmeter to monitor the signal source output.
- (3) Turn the DEV RANGE switch to 5 kc/s and the DE-EMPHASIS switch to OFF.
- (4) Set the signal source frequency to 1 kc/s and adjust its output to give full-scale deflection on the TF 2300 meter.
- (5) Turn the DEV RANGE switch to 15 kc/s. Increase the signal source output by 10 dB and note that the meter reads within $\pm 1\%$ of full-scale.
- (6) Repeat step (5) for the 50, 150 and 500 kc/s deviation ranges.
- (7) Switch off the TF 2300, remove the test equipment and reconnect the yellow lead to the discriminator output.

5.4.8 A.M. and i.f. response

Test equipment: j and k

- (1) On the a. m. detector unit (A11) disconnect the links from pins 17 and 18. Then connect the signal source between pins 18 and 10 (earth).
- (2) Turn the % A. M. RANGE switch to 100% and the Function switch to A. M. PEAK.
- (3) Connect one voltmeter across the OUTPUT terminals and another to monitor the signal source output.
- (4) Set the signal source frequency to 10 kc/s and its output to give a reading of 100% on the TF 2300 meter. Note the reference level on the output voltmeter.
- (5) Vary the signal source frequency, keeping the level constant, between 30 c/s and 50 kc/s and note that the reading on the output voltmeter is flat to within ± 0.25 dB of the reference level.
- (6) Switch off the TF 2300, remove the test equipment and replace the link between A11 pins 17 and 18.

5.4.9 Discriminator trigger

Test equipment: a

- (1) With the modulation meter switched off disconnect the lead from pin 2 on the discriminator unit (A5) and connect the multi-meter to the collector of A5VT2 (or VT3).
- (2) Switch on and adjust A5RV1 to the point at which the circuit is at the change of state, i. e., the collector voltage is on the point of changing from 0 to 15 V or vice versa.
- (3) Switch off, disconnect the meter and reconnect the lead to pin 2.

5.4.10 Set i.f.

Test equipment: l

- (1) Connect the crystal oscillator to the R. F. IN socket.

Set with 100% of output section signal in removed output is gone (no noise)

- (2) Turn the oscillator RANGE switch to EXT and the Function switch to TUNE.
- (3) Set the LEVEL control for a meter reading at the top end of the black R. F. LEVEL arc.
- (4) Turn the Function switch to F. M. SET FREQ and adjust A4L1 through the hole in the limiter/discriminator cover (see Fig. 4.2) to bring the meter reading to the SET mark.

5.4.11 L.F. and discriminator noise

Test equipment: l, m, n and o

- (1) Connect the 0.014 μ F capacitor, r. m. s. voltmeter and oscilloscope across the OUTPUT terminals.
- (2) Turn the oscillator RANGE switch to EXT.
- (3) Connect the 1.5 Mc/s crystal oscillator to the R. F. IN socket and turn the MAX MOD FREQ switch to 15 kc/s.
- (4) Turn the Function switch to SET FREQ-F. M. and check that the TF 2300 meter deflects to the SET mark.
- (5) Turn the Function switch to TUNE and adjust the LEVEL control to bring the TF 2300 meter reading to the top end of the black R. F. LEVEL arc.
- (6) Turn the Function switch to SET CAL and adjust the r. m. s. voltmeter range switch to give a convenient reference level. Note this reference level.
- (7) Turn the Function switch to DEV+ and the RANGE switch to 5 kc/s. Turn down the external voltmeter range switch and check that the reading is at least 52 dB below the reference level, i. e. -72 dB relative to the level of 50 kc/s deviation.
- (8) If not, remove the yellow lead from the discriminator output, A5 pin 4 (see Fig. 5.3) and check that the noise level drops to -58 dB. A high noise figure can be improved by selection of transistors VT3, VT4, VT5 and VT6 in the discriminator (A5) and/or by selecting a new value for A5R13.

5.5 REPLACEMENT OF SUB-ASSEMBLIES

Oscillator

Remove the instrument case, disconnect the plug to the mixer unit and withdraw the lead and plug into the oscillator compartment. Remove the chrome screws at each corner of the oscillator front panel and slide the unit out. To remove completely, disconnect the supply plug from within the oscillator compartment. When withdrawn, all presets, coils etc., are accessible without further dismantling.

R.F. attenuator and mixer

It is not advisable to attempt any removal of these items, the former being a sealed unit. In all cases, contact Marconi Instruments if repair appears necessary in this unit.

Printed circuit boards

The following are plug in circuit boards which, apart from A13, can be removed by pressing a spring clip and pulling the board upwards:

- (1) 1st l. f. amplifier (A7).
- (2) 2nd l. f. amplifier (A9).
- (3) A. M. detector (A11).
- (4) Peak reading voltmeter (A10).
- (5) Calibrator (A12).
- (6) Power supply unit (A13).

(This board is secured by a bracket which has to be removed before the board can be unplugged.)

An extension board, type TM 7926, is stowed on the inside of the rear panel. By means of this board, any of the above can be raised above its compartment for examination while in the operative condition.

I.F. amplifier

The complete amplifier can be removed when necessary by unsoldering one lead and disconnecting two miniature plugs. Three screws retain the unit to the chassis. Access for adjustment is provided by a removable cover, thus enabling the inductors of the tuned circuits to be adjusted through holes in the back of the circuit boards with a trimmer tool.

Limiter and discriminator

All thirteen connections are soldered; the complete unit can be removed after these have been unsoldered by releasing four nuts from the top side of the chassis. The cover is removable to give access to all the circuits and presets.

150 kc/s and 15 kc/s low-pass filters

Either of these units can be removed by unsoldering two connections and releasing two screws. The 150 kc/s filter is adjustable through holes in the top chassis (immediately below extension board stowage).

Oscillator drive cord

The oscillator drive cord consists of a $3\frac{1}{2}$ ft length of nylon cord arranged as shown in Fig. 5.2. Before fitting, suspend the new cord with a weight of 4 lb (2 kg) for 24 hours.

To fit a new cord:

- (1) Turn the OSCILLATOR TUNE control fully clockwise.
- (2) Attach one end of the cord (X) to the correct spring on pulley C.
- (3) Pass the cord through the slot and once clockwise round pulley C, then over pulley A and counter-clockwise for three-quarters of a turn round the bush to point X'.
- (4) Ease the pin in the bush clear of the hole by means of a small screwdriver. Loop the cord into the hole and push back the pin to anchor it.

- (5) Starting from point Y, wind the cord $7\frac{1}{2}$ times counter-clockwise round the bush, take it over pulley B, through the slot in pulley C and attach it to the other spring at point Y'.

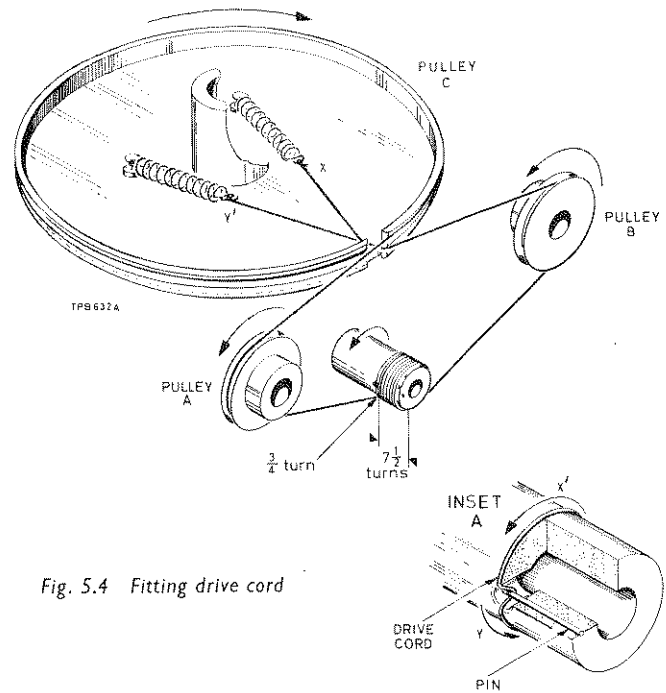

Fig. 5.4 Fitting drive cord

5.6 REPLACEMENT OF COMPONENTS

Fuses

The two fuses are fitted in 20 x 50 mm holders in the rear panel. FS2 is of the quick-blow type. It must never be changed without first switching off the mains supply, or circuit damage may result.

Transistors

Transistors that are mounted in holders may need to be selected for low noise if replaced.

Replaceable parts

Introduction

The modulation meter consists of a number of sub-assemblies, each of which is allocated an identity number in the sequence A0 to A13 inclusive, as follows :-

A0	- Main chassis
A1	- Mixer
A2	- Oscillator assembly
A2a	Oscillator
A2b	Doubler and harmonic generator
A3	- I. F. amplifier
A4	- Limiter
A5	- Discriminator
A6	- 150 kc/s l. p. filter
A7	- 1st l. f. amplifier
A8	- 15 kc/s filter
A9	- 2nd l. f. amplifier
A10	- Peak reading voltmeter
A11	- A. M. detector
A12	- Calibrator
A13	- Power unit assembly

The complete reference of a part consists of the sub-assembly number followed by its circuit reference, e. g. , A4C5, A7R4, etc. , and this should always be stated on any order, letter, etc. For convenience in the text and on circuit diagrams, the circuit reference is abbreviated by dropping the sub-assembly prefix except where there is risk of ambiguity.

Replaceable parts are grouped in order of sub-assembly designation and itemized in alphabetical order of circuit references, with miscellaneous parts at the end of each list. The following abbreviations are used :-

C	: capacitor
Carb	: carbon
Cer	: ceramic
CRT	: cathode ray tube
Elec	: electrolytic
FS	: fuse
ILP	: illumination lamp
JK	: jack
L	: inductor
Log	: logarithmic law
M	: meter

Met	: metal
Min	: minimum value
MR	: semiconductor diode
Ox	: oxide
PL	: plug
Plas	: plastic
PLP	: pilot lamp
R	: resistor
RV	: variable resistor
S	: switch
SKT	: socket
T	: transformer
TE	: total excursion
TH	: thermistor
TP	: terminal
V	: valve
Var	: variable or preset
VT	: transistor
WW	: wirewound
X	: ferrite bead
†	: value selected during test; nominal value listed
∅	: feed-through component
W*	: watts at 70 °C
W**	: watts at 55 °C
W***	: watts at 40 °C
W ⁰	: watts at unspecified temperature

Ordering

When ordering replacement or spare parts, address the order to our Service Division (for address see rear cover) or nearest representative. Please specify the following information for each part required.

- (1) Type and serial number of instrument (see rear data plate).
- (2) Complete circuit reference (see Introduction).
- (3) Description.
- (4) M. I. code number.

If a part is not listed, state its function, location and description when ordering.

Transistor selection

Transistors that are mounted in holders may need to be selected for low noise if replaced.

Additional component description

Detailed information on capacitors, additional to that given in the Description column of the parts lists, is included in Table 6.1.

TABLE 6.1
Capacitor details

M.I. code	Component type
26174-101/199	Metallized, tubular, plastic case.
26258-101/399	Silvered, rectangular moulded case.
26324-001/999	Low K, tubular case, epitex insulated.
26372-601/619	High K, lead-through.
26383-001/699	Disk type, epitex insulated.
26412-101/449	Etched foil, tubular metal case.
26414-101/359	Etched foil, tubular metal case.
26417-001/729	Etched foil, tubular metal case.
26427-301/399	Fabricated plate, cylindrical metal case, plug-in mounting, printed circuit.
26485-251/299	Tantalum pellet, plastic case, slide wire terminations.
26516-001/899	Tubular case.
26518-001/819	Unprotected.
26582-201/249	Metal rectangular, moulded case
26817-201/239	Var. , trimmer type, solid electrode, printed circuit.

A0—MAIN ASSEMBLY, TF 2300 AND RANGE ATTENUATOR

When ordering, prefix circuit reference with A0.

Circuit reference	Description	M.I. code	Circuit reference	Description	M.I. code
			PLA	R F miniature	23441-014
			PLB	R F miniature	23441-014
			PLC	R F miniature	23441-014
C1	Cer 0.1 μ F +50-25% 25 V	26383-031			
C2	Cer 0.1 μ F +50-25% 25 V	26383-031	R1	Carb 10 k Ω \pm 10% 0.1 W*	24341-310
C3	Cer 0.1 μ F +50-25% 25 V	26383-031	R2	Met film 1.222 k Ω \pm 0.5% $\frac{1}{4}$ W*	24635-006
C4	Cer 0.1 μ F +50-25% 25 V	26383-031	R3	Met film 4.95 k Ω \pm 0.5% $\frac{1}{4}$ W*	24635-104
C5	Plas 0.201 μ F \pm 1% 50 V	26518-330	R4	Met film 1.222 k Ω \pm 0.5% $\frac{1}{4}$ W*	24635-006
C6	Plas 0.302 μ F \pm 1% 50 V	26518-341	R6	Met ox 22 Ω \pm 7% TE 3/8W**	24552-028
C7	Plas 0.047 μ F \pm 10% 250 V	26582-206	R8	Met film 1.925 k Ω \pm 0.5% $\frac{1}{4}$ W*	24635-008
C8	Cer 0.1 μ F +50-25% 25 V	26383-031	R9	Met film 1.423 k Ω \pm 0.5% $\frac{1}{4}$ W*	24635-009
C9	Cer 0.1 μ F +50-25% 25V	26383-031	R10	Met film 1.925 k Ω \pm 0.5% $\frac{1}{4}$ W*	24635-008
M1	Meter 100 μ A f. s. d. 800 Ω	44572-209	R11	Met film 1.222 k Ω \pm 0.5% $\frac{1}{4}$ W*	24635-006

For symbols and abbreviations see introduction to this section

When ordering, prefix circuit reference with A0.

Circuit reference	Description	M.I. code
R12	Met film 4.95 kΩ ± 0.5% ¼W*	24635-104
R13	Met film 1.18 kΩ +0.5% ¼W*	24635-004
R14	Met film 1.027 kΩ ±0.5% ¼W*	24635-005
R15	Met film 27.5 kΩ ±0.5% ¼W*	24635-553
R16	Met film 1.027 kΩ ±0.5% ¼W*	24635-005
R17	Met ox 100 kΩ ±7% TE 3/8 W**	24552-135
R18	Carb 220 kΩ ±10% 1/10 W*	24341-343
R19 †	Carb 220 kΩ ±10% ¼W	24342-143
RV1	Carb 5 kΩ ±20% 2 W*	25645-374
RV2	Carb 50 kΩ ±20% 2 W*	25645-421
RV3	WW 5 kΩ ±10% 1 W ^O	25815-129
RV4	WW 500 Ω ±10% 1W ^O	25815-104
RV5	WW 500 Ω ±10% 1W ^O	25815-104
SKTA	50 Ω, BNC, I. F. OUT	23443-443
SKTB	2-pin	23421-504
SA	2 sec., 2 pos., SUPPLY	44321-406
SB	11 sec., 9 pos., Function	44325-901
SC	3 sec., 5 pos., A. M./DEV RANGE	44324-414
SD	1 sec., 3 pos., DE-EMPHASIS	44322-128
SE	1 sec., 2 pos., MAX MOD FREQ	44321-131
	Round knob, LEVEL	41141-209
	Round knob, SET A. M.	41141-202
	Skirted round knob, SUPPLY	41142-209
	Bar knob, large, A. M./DEV RANGE or Function	41145-206
	Bar knob, small, MAX MOD FREQ or DE-EMPHASIS	41145-208
	Terminal post, OUTPUT, insulated	23235-176

When ordering, prefix circuit reference with A0.

Circuit reference	Description	M.I. code
	Terminal post, OUTPUT, earthed	23235-177
	Case foot, (1 of 4)	37573-107
A1—MIXER, TM 7723		
When ordering, prefix circuit reference with A1.		
AT1	50 Ω, 65 dB	44425-505
C1	Cer 33 pF ±5% 750 V	26324-822
MR1	1N21C	28348-131
R1	Carb 2.7 kΩ ±10% 0.1 W*	24341-292
R2	Carb 470 Ω ±10% 0.1 W*	24341-269
R3	Carb 56 Ω ±10% 0.1 W*	24341-240
R4	Carb 10 kΩ ±10% 0.1 W*	24341-310
SKTA	R F miniature, o/p to i. f. amp.	23441-044
SKTB	50 Ω, BNC, i/p from oscillator	23443-413
SKTC	50 Ω, BNC, RF IN	23443-503
A2—OSCILLATOR ASSEMBLY, TM 8045		
When ordering, prefix circuit reference with A2.		
C1	Plas 680 pF ±2% 125 V	26516-444
C2	Cer 4700 pF 350 V	26372-665
C3	Elec 10 μF +100-20% 6 V	26414-120
PLA	Plug, 2 pin	23421-204
	Socket, CRYSTAL (1 of 3)	28313-605
SKTA	50 Ω, BNC, EXT OSC	23443-503

For symbols and abbreviations see introduction to this section

When ordering, prefix circuit reference with A2.

Circuit reference	Description	M.I. code
	Knob, CRYSTAL	41141-215
	Knob, RANGE	41141-005
	Knob, fine OSCILLATOR TUNE (plastic)	41141-203
	Knob, coarse OSCILLATOR TUNE (aluminium)	31141-706
	Lead assembly, osc. output to mixer	43122-042
	Lead assembly, ext. osc. input	43123-025
	Oscillator drive cord, 3½ ft long	16410-604
	Transit clip for locking carriage plate	35461-106

A2a—OSCILLATOR BOARD, TM 7705

When ordering, prefix circuit reference with A2a.

C1	Var air 2.5-13.4 pF	26817-238
C2	Plas 220 pF ±2% 125 V	26516-327
C3	Plas 0.001 μF ±2% 125 V	26516-481
C4	Plas 100 pF ±2% 500 V	26516-245
C5	Cer 47 pF ±2% 750 V	26324-833
C6	Cer 0.1 μF +50-25% 25 V	26383-031
C7	Cer 0.1 μF +50-25% 25 V	26383-031
C8	Cer 0.1 μF +50-25% 25 V	26383-031
C9	Cer 2.2 pF ±0.5 pF 750 V	26324-042
C10	Cer 68 pF ±2% 750 V	26324-868
C11	Cer 22 pF ±5% 750 V	26324-807
C12	Cer 22 pF ±5% 750 V	26324-807
C13	Plas 100 pF ±2% 500 V	26516-245
C14	Var air 2.5-13.4 pF	26817-238
C15	Cer 0.1 μF +50-25% 25 V	26383-031

When ordering, prefix circuit reference with A2a.

Circuit reference	Description	M.I. code
L2	Assembly TM 8073/3	44221-404
L4	Assembly TM 8073/4	44221-012
PLA	H. T. to oscillator	23443-305
PLB	O/P to mixer	23442-305
R1	Carb 220 Ω ±10% 0.1 W*	24341-258
R2	Carb 27 Ω ±10% 0.1 W*	24341-231
R3	Carb 27 Ω ±10% 0.5 W**	24342-031
R4	Carb 220 Ω ±10% 0.1 W*	24341-258
R5	Met ox 180 Ω ±7% TE 3/8 W**	24552-056
R6	Met ox 27 kΩ ±7% TE 3/8 W**	24552-120
R7	Met ox 15 kΩ ±7% TE 3/8 W**	24552-114
R8	Met ox 15 kΩ ±7% TE 3/8 W**	24552-114
R9	Met ox 7.5 kΩ ±7% TE 3/8 W**	24552-107
R10	Met ox 220 Ω ±7% TE 3/8 W**	24552-058
R11	Carb 68 Ω ±10% 0.1 W*	24341-243
R12	Carb 27 Ω ±10% 0.5 W**	24342-031
R13 †	Carb 180Ω 1/4W*	24341-256
VT1	A1827	28451-577
VT2	A1827	28451-577

A2b—DOUBLER AND HARMONIC GENERATOR BOARD, TM 7706

When ordering, prefix circuit reference with A2b.

C1	Cer 47 pF ±2% 750 V	26324-833
C2	Cer 6.8 pF ±0.5 pF 750 V	26324-072
C3	Cer 0.1 μF +50-25% 25 V	26383-031
C4	Cer 0.1 μF +50-25% 25 V	26383-031

For symbols and abbreviations see introduction to this section

When ordering, prefix circuit reference with A2b.

A3—I.F. AMPLIFIER, TM 7132

When ordering, prefix circuit reference with A3.

Circuit reference	Description	M.I. code
C5	Cer 68 pF $\pm 2\%$ 750 V	26324-868
C6	Cer 22 pF $\pm 5\%$ 750 V	26324-807
C7	Var air 2.5-13.4 pF	26817-238
C8	Plas 150 pF $\pm 2\%$ 500 V	26516-291
C9	Cer 0.1 μ F +50-25% 25 V	26383-031
C10	Cer 0.01 μ F +80-20% 100 V	26383-055
C11	Paper 0.01 μ F $\pm 10\%$ 200 V	26174-145
C12	Cer 0.1 μ F +50-25% 25 V	26383-031
C13	Cer 0.01 μ F +80-20% 100 V	26383-055
C14	Plas 100 pF $\pm 2\%$ 500 V	26516-245
C15	Cer 0.01 μ F +80-20% 100 V	26383-055
L1	Assembly TM 7928/5	44251-207
L3	Assembly TM 7928/5	44251-207
L4	Assembly TB 22722/100	35124-411
L5	Assembly TM 7928/5	44251-207
L6	Assembly TB 22722/100	35124-411
R1	Carb 27 Ω $\pm 10\%$ 0.5 W**	24342-031
R2	Carb 220 Ω $\pm 10\%$ 0.1 W*	24341-258
R3	Carb 220 Ω $\pm 10\%$ 0.1 W*	24341-258
R4	Carb 100 Ω $\pm 10\%$ 0.1 W*	24341-250
R5	Carb 470 Ω $\pm 10\%$ 0.1 W*	24341-269
R6	Carb 270 Ω $\pm 10\%$ 0.1 W*	24341-261
R7	Carb 100 Ω $\pm 10\%$ 0.1 W*	24341-250
R8	Carb 10 k Ω $\pm 10\%$ 0.1 W*	24341-310
VT1	2N914	28452-136
VT2	2N914	28452-136
VT3	2N914	28452-136
	Transistor pad	28488-113

Circuit reference	Description	M.I. code
C1	Cer 0.1 μ F +50-25% 25 V	26383-031
C2	Cer 0.1 μ F +50-25% 25 V	26383-031
C3	Cer 0.1 μ F +50-25% 25 V	26383-031
C4	Cer 0.1 μ F +50-25% 25 V	26383-031
C5	Mica 352 pF $\pm 1\%$ 750 V	26258-141
C6	Mica 352 pF $\pm 1\%$ 750 V	26258-141
C7	Cer 0.1 μ F +50-25% 25 V	26383-031
C8	Cer 0.1 μ F +50-25% 25 V	26383-031
C9	Cer 0.1 μ F +50-25% 25 V	26383-031
C10	Cer 0.1 μ F +50-25% 25 V	26383-031
C11	Mica 352 pF $\pm 1\%$ 750 V	26258-141
C12	Mica 352 pF $\pm 1\%$ 750 V	26258-141
C13	Cer 0.1 μ F +50-25% 25 V	26383-031
C14	Cer 0.1 μ F +50-25% 25 V	26383-031
C15	Cer 0.1 μ F +50-25% 25 V	26383-031
C16	Cer 0.1 μ F +50-25% 25 V	26383-031
C17	Cer 0.1 μ F +50-25% 25 V	26383-031
C18	Cer 0.1 μ F +50-25% 25 V	26383-031
C19	Cer 0.001 μ F	26372-611
L1	55.2 μ H	44257-402
L2	55.2 μ H	44257-402
L3	55.2 μ H	44257-402
L4	55.2 μ H	44257-402
L5	55.2 μ H	44257-402
L6	55.2 μ H	44257-402
R1	Met ox 3.9 k Ω $\pm 7\%$ TE 3/8 W**	24552-096
R2	Met ox 18 k Ω $\pm 7\%$ TE 3/8 W**	24552-116
R3	Met ox 820 Ω $\pm 7\%$ TE 3/8 W**	24552-078

For symbols and abbreviations see introduction to this section

When ordering, prefix circuit reference with A3.

A4—LIMITER, TM 7285

When ordering, prefix circuit reference with A4.

Circuit reference	Description	M.I. code
R4	Met ox 200 Ω $\pm 7\%$ TE 3/8W**	24552-057
R5	Met ox 3.9 k Ω $\pm 7\%$ TE 3/8W**	24552-096
R6	Carb 39 Ω $\pm 10\%$ 0.1 W*	24341-235
R7	Carb 1.5 k Ω $\pm 10\%$ 0.1 W*	24341-284
R8	Met ox 560 Ω $\pm 7\%$ TE 3/8 W**	24552-072
R9	Met ox 470 Ω $\pm 7\%$ TE 3/8 W**	24552-069
R10	Met ox 2.7 k Ω $\pm 7\%$ TE 3/8 W**	24552-092
R11	Met ox 11 k Ω $\pm 7\%$ TE 3/8 W**	24552-111
R12	Met ox 150 Ω $\pm 7\%$ TE 3/8 W**	24552-054
R13	Met ox 2.2 k Ω $\pm 7\%$ TE 3/8 W**	24552-088
R14	Carb 39 Ω $\pm 10\%$ 0.1 W*	24341-235
R15	Carb 1.5 k Ω $\pm 10\%$ 0.1 W*	24341-284
R16	Met ox 560 Ω $\pm 7\%$ TE 3/8 W**	24552-072
R17	Met ox 470 Ω $\pm 7\%$ TE 3/8 W**	24552-069
R18	Met ox 18 k Ω $\pm 7\%$ TE 3/8 W**	24552-116
R19	Met ox 4.7 k Ω $\pm 7\%$ TE 3/8 W**	24552-100
R20	Met ox 3.3 k Ω $\pm 7\%$ TE 3/8 W**	24552-094
R21	Met ox 560 Ω $\pm 7\%$ TE 3/8 W**	24552-072
R22	Met ox 1.2 k Ω $\pm 7\%$ TE 3/8 W**	24552-082
R23	Carb 22 Ω $\pm 10\%$ 0.1 W*	24341-228
R24	Carb 680 Ω $\pm 10\%$ 0.1 W*	24341-276
SKTA	R F miniature	23441-044
SKTB	R F miniature	23441-044
VT1	MPS 3640	28431-766
VT2	MPS 3640	28431-766
VT3	MPS 3640	28431-766
VT4	BCY 72	28433-487
VT5	BCY 72	28433-487
VT6	BCY 72	28433-487

Circuit reference	Description	M.I. code
C1	Cer 0.1 μ F +50-25% 25 V	26383-031
C2	Cer 0.1 μ F +50-25% 25 V	26383-031
C3	Cer 0.1 μ F +50-25% 25 V	26383-031
C4	Cer 0.1 μ F +50-25% 25 V	26383-031
C5	Cer 0.1 μ F +50-25% 25 V	26383-031
C6	Cer 0.1 μ F +50-25% 25 V	26383-031
C7	Cer 0.1 μ F +50-25% 25 V	26383-031
C8	Cer 0.1 μ F +50-25% 25 V	26383-031
C9	Cer 0.1 μ F +50-25% 25 V	26383-031
C10	Cer 0.1 μ F +50-25% 25 V	26383-031
C11	Cer 0.1 μ F +50-25% 25 V	26383-031
C12	Cer 0.1 μ F +50-25% 25 V	26383-031
C13	Cer 0.0047 μ F	26372-615
C14	Cer 0.0047 μ F	26372-615
L1	Assembly TM 8073/2	44253-208
MR1	CG85H	28321-201
R1	Carb 1 k Ω $\pm 10\%$ 0.1 W*	24341-280
R2	Carb 330 Ω $\pm 10\%$ 0.1 W*	24341-263
R3	Carb 680 Ω $\pm 10\%$ 0.1 W*	24341-276
R4	Carb 470 Ω $\pm 10\%$ 0.1 W*	24341-269
R5	Carb 100 Ω $\pm 10\%$ 0.1 W*	24341-250
R6	Carb 680 Ω $\pm 10\%$ 0.1 W*	24341-276
R7	Carb 330 Ω $\pm 10\%$ 0.1 W*	24341-263
R8	Carb 1 k Ω $\pm 10\%$ 0.1 W*	24341-280
R9	Carb 1 k Ω $\pm 10\%$ 0.1 W*	24341-280
R10	Carb 330 Ω $\pm 10\%$ 0.1 W*	24341-263

For symbols and abbreviations see introduction to this section

When ordering, prefix circuit reference with A4.

Circuit reference	Description	M.I. code
R11	Carb 470 Ω $\pm 10\%$ 0.1 W*	24341-269
R12	Carb 100 Ω $\pm 10\%$ 0.1 W*	24341-250
R13	Carb 680 Ω $\pm 10\%$ 0.1 W*	24341-276
R14	Carb 330 Ω $\pm 10\%$ 0.1 W*	24341-263
R15	Met ox 2 k Ω $\pm 7\%$ TE 3/8 W**	24552-087
R16	Carb 1 k Ω $\pm 10\%$ 0.1 W*	24341-280
R17	Carb 330 Ω $\pm 10\%$ 0.1 W*	24341-263
R18	Met ox 560 Ω $\pm 7\%$ TE 3/8 W**	24552-072
R19	Met ox 470 Ω $\pm 7\%$ TE 3/8 W**	24552-069
R20	Carb 100 Ω $\pm 10\%$ 0.1 W*	24341-250
R21	Carb 180 Ω $\pm 10\%$ 0.1 W*	24341-256
R22	Carb 330 Ω $\pm 10\%$ 0.1 W*	24341-263
R23	Met ox 2.2 k Ω $\pm 7\%$ TE 3/8 W**	24552-088
R24	Met ox 2.2 k Ω $\pm 7\%$ TE 3/8 W**	24552-088
RV1	Carb 100 Ω $\pm 20\%$ $\frac{1}{4}$ W**	25611-102
RV2	Carb 100 Ω $\pm 20\%$ $\frac{1}{4}$ W**	25611-102
RV3	Carb 100 Ω $\pm 20\%$ $\frac{1}{4}$ W**	25611-102
VT1	BCY 72	28433-487
VT2	BCY 72	28433-487
VT3	BCY 72	28433-487
VT4	BCY 72	28433-487
VT5	BCY 72	28433-487
VT6	BCY 72	28433-487
X1	Ferrite bead, Mullard FX1115	23635-833
X2	Ferrite bead, Mullard FX1115	23635-833
X3	Ferrite bead, Mullard FX1115	23635-833
X4	Ferrite bead, Mullard FX1115	23635-833
X5	Ferrite bead, Mullard FX1115	23635-833

A5—DISCRIMINATOR, TM 7780
When ordering, prefix circuit reference with A5.

Circuit reference	Description	M.I. code
C1	Carb 0.1 μ F +50-25% 25 V	26383-031
C2	Cer 10 pF ± 0.5 pF 750 V	26324-085
C3	Cer 10 pF ± 0.5 pF 750 V	26324-085
C4	Cer 22 pF $\pm 5\%$ 750 V	26324-807
C5	Carb 0.1 μ F +50-25% 25 V	26383-031
C6	Plas 30 pF ± 2 pF 500 V	26516-119
C7	Elec 100 μ F +100-20% 25 V	26417-158
C8	Carb 0.1 μ F +50-25% 25 V	26383-031
C9	Carb 0.1 μ F +50-25% 25 V	26383-031
C10	Elec 100 μ F +100-20% 25 V	26417-158
C11	Carb 0.1 μ F +50-25% 25 V	26383-031
C12	Carb 0.1 μ F +50-25% 25 V	26383-031
C13	Cer 0.0047 μ F	26372-615
C14	Cer 0.0047 μ F	26372-615
MR1	CG85H	28321-201
MR2	CG85H	28321-201
R1	Carb 1.5 k Ω $\pm 10\%$ $\frac{1}{2}$ W**	24342-084
R2	Carb 1.8 k Ω $\pm 10\%$ $\frac{1}{2}$ W**	24342-086
R3	Carb 3.3 k Ω $\pm 10\%$ $\frac{1}{2}$ W**	24342-094
R4	Carb 33 Ω $\pm 10\%$ $\frac{1}{2}$ W**	24342-033
R5	Carb 1 k Ω $\pm 10\%$ $\frac{1}{2}$ W**	24342-080
R6	Carb 100 Ω $\pm 10\%$ $\frac{1}{2}$ W**	24342-050
R7	Carb 1 k Ω $\pm 10\%$ $\frac{1}{2}$ W**	24342-080
R8	Carb 10 k Ω $\pm 10\%$ $\frac{1}{2}$ W**	24342-110
R9	Carb 22 k Ω $\pm 10\%$ $\frac{1}{2}$ W**	24342-118
R10	Met ox 3 k Ω $\pm 7\%$ TE 3/8 W**	24552-093
R11	Carb 10 k Ω $\pm 10\%$ $\frac{1}{2}$ W**	24342-110
R12	Met ox 1 k Ω $\pm 7\%$ TE 3/8 W**	24552-080
R13	Met ox 200 Ω $\pm 7\%$ TE 3/8 W**	24552-057

For symbols and abbreviations see introduction to this section

When ordering, prefix circuit reference with A5.

Circuit reference	Description	M.I. code
R14	Met ox 1 k Ω $\pm 7\%$ TE 3/8W**	24552-080
R15	Met ox 6.8 k Ω $\pm 7\%$ TE 3/8W**	24552-106
R16	Carb 10 Ω $\pm 10\%$ $\frac{1}{2}$ W**	24342-020
R17	Carb 470 Ω $\pm 10\%$ $\frac{1}{2}$ W**	24342-069
R18	Carb 470 Ω $\pm 10\%$ $\frac{1}{2}$ W**	24342-069
RV1	Carb 4.7 k Ω $\pm 20\%$ $\frac{1}{4}$ W**	25611-209
VT1	2N706	28433-356
VT2	2N706	28433-356
VT3	2N706	28433-356
VT4	BC109	28452-777
VT5	BSY27	28452-843
VT6	BC109	28452-777
VT7	BC109	28452-777
X1	Ferrite bead, Mullard FX1115	23635-833
X2	Ferrite bead, Mullard FX1115	23635-833
X3	Ferrite bead, Mullard FX1115	23635-833

A6—150 kc/s FILTER, TM 7700

When ordering, prefix circuit reference with A6.

C1	Mica 720 pF $\pm 1\%$ 350 V	26258-150
C2	Mica 0.00144 μ F $\pm 1\%$ 350 V	26258-185
C3	Mica 720 pF $\pm 1\%$ 350 V	26258-150
L1	Assembly TM 7842	44266-821
L2	Assembly TM 7842	44266-821
R1	Met film 1 k Ω $\pm 1\%$ $\frac{1}{4}$ W**	24637-101

A7—1st L.F. AMPLIFIER, TM 7223

When ordering, prefix circuit reference with A7.

Circuit reference	Description	M.I. code
C1	Elec 500 μ F +50-20% 12 V	26417-172
C2	Elec 100 μ F +100-20% 25 V	26417-158
C3	Cer 15 pF $\pm 5\%$ 750 V	26324-795
C4	Elec 100 μ F +50-20% 6 V	26417-154
C5	Elec 100 μ F +100-20% 25 V	26417-158
C6	Elec 100 μ F +50-20% 6 V	26417-154
C7	Elec 500 μ F +50-20% 12 V	26417-172
R1	Carb 100 Ω $\pm 10\%$ $\frac{1}{2}$ W**	24342-050
R2	Met film 1 k Ω $\pm 1\%$ $\frac{1}{4}$ W*	24637-101
R3	Carb 5.6 k Ω $\pm 10\%$ $\frac{1}{2}$ W**	24342-103
R4	Carb 2.2 k Ω $\pm 10\%$ $\frac{1}{2}$ W**	24342-088
R5	Carb 4.7 k Ω $\pm 10\%$ $\frac{1}{2}$ W**	24342-100
R6	Carb 5.6 k Ω $\pm 10\%$ $\frac{1}{2}$ W**	24342-103
R7	Met ox 6.8 k Ω $\pm 7\%$ TE 3/8W**	24552-106
R8	Met ox 20 k Ω $\pm 7\%$ TE 3/8 W**	24552-117
R9	Carb 2.2 k Ω $\pm 10\%$ $\frac{1}{2}$ W**	24342-088
R10	Carb 56 Ω $\pm 10\%$ $\frac{1}{2}$ W**	24342-040
R11	Carb 82 Ω $\pm 10\%$ $\frac{1}{2}$ W**	24342-046
R12	Carb 22 k Ω $\pm 10\%$ $\frac{1}{2}$ W**	24342-118
R13	Carb 1 k Ω $\pm 10\%$ $\frac{1}{2}$ W**	24342-080
R14	Met film 1 k Ω $\pm 1\%$ $\frac{1}{4}$ W*	24637-101
VT1	BCY 72	28433-487
VT2	BCY 72	28433-487
VT3	2N1304	28443-528
VT4	2N1304	28443-528

For symbols and abbreviations see introduction to this section

A8—15 kc/s FILTER, TM 7702

When ordering, prefix circuit reference with A8.

Circuit reference	Description	M.I. code
C1	Plas 0.0067 μ F $\pm 1\%$ 125 V	26516-683
C2	Plas 0.0067 μ F $\pm 1\%$ 125 V	26516-683
L1	Assembly TM 7842/1	44271-409

A9—2nd L.F. AMPLIFIER, TM 7224

When ordering, prefix circuit reference with A9.

C1	Elec 500 μ F +50-20% 12 V	26417-172
C2	Cer 0.1 μ F +50-20% 25 V	26383-031
C3	Cer 15 pF $\pm 5\%$ 750 V d. c.	26324-795
C4	Elec 100 μ F +100-20% 25 V	26417-158
C5	Elec 100 μ F +50-20% 6 V	26417-154
C6	Elec 100 μ F +50-20% 6 V	26417-154
C7	Elec 500 μ F +50-20% 12 V	26417-172
C8	Cer 15 pF $\pm 5\%$ 750 V d. c.	26324-795
C9	Elec 100 μ F +50-20% 6 V	26417-154
C10	Elec 100 μ F +50-20% 6 V	26417-154
C11	Elec 500 μ F +50-20% 12 V	26417-172
C12	Elec 100 μ F +100-20% 25 V	26417-158
R1	Carb 47 Ω $\pm 10\%$ $\frac{1}{2}$ W**	24342-037
R2	Met film 1 k Ω $\pm 1\%$ $\frac{1}{4}$ W*	24637-101
R3	Carb 5.6 k Ω $\pm 10\%$ $\frac{1}{2}$ W**	24342-103

When ordering, prefix circuit reference with A9.

Circuit reference	Description	M.I. code
R4	Carb 2.2 k Ω $\pm 10\%$ $\frac{1}{2}$ W**	24342-088
R5	Carb 4.7 k Ω $\pm 10\%$ $\frac{1}{2}$ W**	24342-100
R6	Carb 5.6 k Ω $\pm 10\%$ $\frac{1}{2}$ W**	24342-103
R7	Met ox 20 k Ω $\pm 7\%$ TE 3/8 W*	24552-117
R8	Met ox 10 k Ω $\pm 7\%$ TE 3/8 W*	24552-110
R9	Carb 2.2 k Ω $\pm 10\%$ $\frac{1}{2}$ W**	24342-088
R10	Met film 500 Ω $\pm 1\%$ $\frac{1}{4}$ W*	24636-808
R11	Met film 500 Ω $\pm 1\%$ $\frac{1}{4}$ W*	24636-808
R12	Carb 5.6 k Ω $\pm 10\%$ $\frac{1}{2}$ W**	24342-103
R13	Carb 2.2 k Ω $\pm 10\%$ $\frac{1}{2}$ W**	24342-088
R14	Carb 4.7 k Ω $\pm 10\%$ $\frac{1}{2}$ W**	24342-100
R15	Carb 5.6 k Ω $\pm 10\%$ $\frac{1}{2}$ W**	24342-103
R16	Met ox 20 k Ω $\pm 7\%$ TE 3/8 W*	24552-117
R17	Carb 2.2 k Ω $\pm 10\%$ $\frac{1}{2}$ W**	24342-088
R18	Carb 56 Ω $\pm 10\%$ $\frac{1}{2}$ W**	24342-040
R19	Carb 82 Ω $\pm 10\%$ $\frac{1}{2}$ W**	24342-046
R20	Carb 22 k Ω $\pm 10\%$ $\frac{1}{2}$ W**	24342-118
R21	Carb 1 k Ω $\pm 10\%$ $\frac{1}{2}$ W**	24342-080
R22	Met film 600 Ω $\pm 1\%$ $\frac{1}{4}$ W*	24636-802
RV1	WW 22 k Ω $\pm 10\%$ 1W*	25811-554
VT1	BCY 72	28433-487
VT2	BCY 72	28433-487
VT3	BCY 72	28433-487
VT4	BCY 72	28433-487
VT5	2N1304	28443-528
VT6	2N1304	28443-528

For symbols and abbreviations see introduction to this section

A10—PEAK READING VOLTMETER, TM 7218

When ordering, prefix circuit reference with A10.

Circuit reference	Description	M.I. code
C1	Elec 100 μ F +100-20% 6 V	26417-154
C2	Cer 0.1 μ F +50-25% 25 V	26383-031
C3	Elec 500 μ F +50-20% 12 V	26417-172
C4	Elec 100 μ F +100-20% 25 V	26417-158
C5	Elec 100 μ F +100-20% 6 V	26417-154
C6	Elec 100 μ F +100-20% 6 V	26417-154
C7	Elec 100 μ F +100-20% 25 V	26417-158
C8	Elec 15 μ F \pm 20% 15 V	26485-278
C9	Elec 100 μ F +100-20% 25 V	26417-158
C10	Elec 100 μ F +100-20% 6 V	26417-154
C11	Elec 100 μ F +100-20% 6 V	26417-154
C12	Elec 100 μ F +100-20% 25 V	26417-158
C13	Cer 6.8 pF \pm 0.5 pF 750 V	26324-072
C14	Paper 0.01 μ F \pm 10% 200 V	26174-145
MR1	1N914	28336-676
R1	Met ox 3.9 k Ω \pm 7% TE 3/8 W**	24552-096
R2	Carb 5.6 k Ω \pm 10% $\frac{1}{2}$ W**	24342-103
R3	Met ox 15 k Ω \pm 7% TE 3/8 W**	24552-114
R4	Carb 2.7 k Ω \pm 10% $\frac{1}{2}$ W**	24342-092
R5	Carb 4.7 k Ω \pm 10% $\frac{1}{2}$ W**	24342-100
R6	Carb 2.2 k Ω \pm 10% $\frac{1}{2}$ W**	24342-088
R7	Met ox 1.2 k Ω \pm 7% TE 3/8 W**	24552-082
R8	Carb 10 k Ω \pm 10% $\frac{1}{2}$ W*	24342-110
R9	Carb 2.2 k Ω \pm 10% $\frac{1}{2}$ W**	24342-088
R10	Carb 5.6 k Ω \pm 10% $\frac{1}{2}$ W**	24342-103
R11	Carb 4.7 k Ω \pm 10% $\frac{1}{2}$ W**	24342-100
R12	Met ox 20 k Ω \pm 7% TE 3/8 W**	24552-117
R13	Met ox 470 Ω \pm 7% TE 3/8 W**	24552-069

When ordering, prefix circuit reference with A10.

Circuit reference	Description	M.I. code
R14	Met ox 1 k Ω \pm 7% TE 3/8 W**	24552-080
R15	Met ox 68 k Ω \pm 7% TE 3/8 W**	24552-131
R16	Met ox 20 k Ω \pm 7% TE 3/8 W**	24552-117
R17	Met ox 1 k Ω \pm 7% TE 3/8 W**	24552-080
R18	Met ox 470 Ω \pm 7% TE 3/8 W**	24552-069
R19	Met ox 20 k Ω \pm 7% TE 3/8 W**	24552-117
R20	Carb 2.2 k Ω \pm 10% $\frac{1}{2}$ W**	24342-088
R21	Carb 5.6 k Ω \pm 10% $\frac{1}{2}$ W**	24342-103
R22	Carb 4.7 k Ω \pm 10% $\frac{1}{2}$ W**	24342-100
R23	Carb 10 k Ω \pm 10% $\frac{1}{2}$ W**	24342-110
R24	Carb 470 k Ω \pm 10% $\frac{1}{2}$ W**	24342-152
RV1	WW 1.5 k Ω \pm 10% 1 W	25811-542
VT1	BCY 72	28433-487
VT2	BCY 72	28433-487
VT3	BCY 72	28433-487
VT4	2N706	28433-356
VT5	2N706	28433-356
VT6	BCY 72	28433-487

A11—A.M. DETECTOR, TM 7276

When ordering, prefix circuit reference with A11.

C1	Cer 0.1 μ F +50-25% 25 V	26383-031
C2	Cer 0.1 μ F +50-25% 25 V	26383-031
C3	Cer 0.1 μ F +50-25% 25 V	26383-031
C4	Plas 680 pF \pm 2% 125 V	26516-444
C5	Cer 0.1 μ F +50-25% 25 V	26383-031

For symbols and abbreviations see introduction to this section

When ordering, prefix circuit reference with A11.

Circuit reference	Description	M.I. code
C6	Plas 0.0028 μ F $\pm 2\%$ 125 V	26516-591
C7	Plas 0.0028 μ F $\pm 2\%$ 125 V	26516-591
C8	Plas 0.0028 μ F $\pm 2\%$ 125 V	26516-591
C9	Plas 0.0028 μ F $\pm 2\%$ 125 V	26516-591
L1	Assembly TM 8073/1	44251-004
L2	Assembly TM 7842/1	44267-403
L3	Assembly TM 7842/1	44267-403
MR1	CG85H	28321-201
R1	Met ox 2 k Ω $\pm 7\%$ TE 3/8 W**	24552-087
R2	Met ox 620 Ω $\pm 7\%$ TE 3/8 W**	24552-074
R3	Met ox 1 k Ω $\pm 7\%$ TE 3/8 W**	24552-080
R4	Met ox 100 Ω $\pm 7\%$ TE 3/8 W**	24552-050
R5	Met ox 8.2 k Ω $\pm 7\%$ TE 3/8 W**	24552-108
R6	Met ox 20 k Ω $\pm 7\%$ TE 3/8 W**	24552-117
R7	Met ox 20 k Ω $\pm 7\%$ TE 3/8 W**	24552-117
R8	Met ox 1.5 k Ω $\pm 7\%$ TE 3/8 W**	24552-084
R9	Met ox 470 Ω $\pm 7\%$ TE 3/8 W**	24552-069
R10	Met ox 2.7 k Ω $\pm 7\%$ TE 3/8 W**	24552-092
R11	Met film 12 k Ω $\pm 1\%$ $\frac{1}{4}$ W*	24637-513
R12	Met ox 820 Ω $\pm 7\%$ TE 3/8 W**	24552-078
R13	Met ox 330 Ω $\pm 7\%$ TE 3/8 W**	24552-063
VT1	BCY 72	28433-487
VT2	BCY 72	28433-487
VT3	2N706	28433-356

A12—CALIBRATOR, TM 7620

When ordering, prefix circuit reference with A12.

Circuit reference	Description	M.I. code
C1	33 pF $\pm 5\%$ 750 V	26324-822
C2	Plas 0.047 μ F $\pm 10\%$ 250 V	26582-206
C3	Paper 300 pF $\pm 20\%$ 600 V	26174-119
C4	Paper 500 pF $\pm 20\%$ 600 V	26174-122
C5	Plas 0.047 μ F $\pm 10\%$ 250 V	26582-206
C6	Paper 0.001 μ F $\pm 10\%$ 500 V	26174-125
C7	Plas 0.1 μ F $\pm 10\%$ 250 V	26582-208
C8	Paper 0.001 μ F $\pm 10\%$ 500 V	26174-125
C9	Elec 100 μ F +100-20% 25 V	26417-158
C10	Paper 0.004 μ F $\pm 10\%$ 250 V	26174-137
C11	Elec 100 μ F +100-20% 25 V	26417-158
C12	Paper 0.004 μ F $\pm 10\%$ 250 V	26174-137
C13	Paper 0.001 μ F $\pm 10\%$ 500 V	26174-125
C14	Elec 100 μ F +100-20% 25 V	26417-158
C15	Cer 0.1 μ F +50-25% 25 V	26383-031
MR1	CG85H	28321-201
MR2	CG85H	28321-201
R1	Carb 4.7 k Ω $\pm 10\%$ $\frac{1}{2}$ W**	24342-100
R2	Carb 560 Ω $\pm 10\%$ $\frac{1}{2}$ W**	24342-072
R3	Carb 120 k Ω $\pm 10\%$ $\frac{1}{2}$ W**	24342-137
R4	† Carb 180 k Ω $\pm 10\%$ $\frac{1}{2}$ W**	24552-141
R5	Carb 560 Ω $\pm 10\%$ $\frac{1}{2}$ W**	24342-072
R6	Carb 4.7 k Ω $\pm 10\%$ $\frac{1}{2}$ W**	24342-100
R7	Carb 4.7 k Ω $\pm 10\%$ $\frac{1}{2}$ W**	24342-100
R8	Carb 5.6 k Ω $\pm 10\%$ $\frac{1}{2}$ W**	24342-103
R9	Carb 1 k Ω $\pm 10\%$ $\frac{1}{2}$ W**	24342-080
R10	Carb 22 k Ω $\pm 10\%$ $\frac{1}{2}$ W**	24342-118

For symbols and abbreviations see introduction to this section

When ordering, prefix circuit reference with A12.

A13—POWER UNIT ASSEMBLY, TM 7454

When ordering, prefix circuit reference with A13.

Circuit reference	Description	M.I. code	Circuit reference	Description	M.I. code
R11	† Carb 18 kΩ ±10% ½W**	24552-116	C1	Elec 500 μF +50-20% 70 V	26427-323
R12	Carb 1 kΩ ±10% ½W**	24342-080	C2	Elec 500 μF +50-20% 70 V	26427-323
R13	Carb 15 kΩ ±10% ½W**	24342-114	C3	Elec 2 μF +100-20% 70 V	26412-212
R14	Carb 10 kΩ ±10% ½W**	24342-110	C4	Elec 100 μF +100-20% 25 V	26417-158
R15	Carb 22 kΩ ±10% ½W**	24342-118	C5	Elec 250 μF +100-20% 25 V	26417-167
R16	Carb 10 kΩ ±10% ½W**	24342-110	C6	Paper 0.1 μF ±10% 350 V	26174-173
R17	Carb 10 kΩ ±10% ½W**	24342-110	C7	Elec 100 μF +100-20% 25 V	26417-158
R18	Carb 560 Ω ±10% ½W**	24342-072	C8	Elec 250 μF +100-20% 25 V	26417-167
R19	Carb 470 Ω ±10% ½W**	24342-069	C9	Cer 0.0047 μF 350 V	26372-665
R20	Carb 560 Ω ±10% ½W**	24342-072	C10	Cer 0.0047 μF 350 V	26372-665
R21	Carb 10 kΩ ±10% ½W**	24342-110	C11	Cer 0.0047 μF 350 V	26372-665
R22	Carb 15 kΩ ±10% ½W**	24342-114			
R23	Carb 10 kΩ ±10% ½W**	24342-110	FS1	Alternative 100 mA (for 230 V) 160 mA (for 110 V)	23411-052 23411-054
R24	Carb 10 Ω ±10% ½W**	24342-020	FS2	500 mA	23411-005
VT1	2S323	28433-318	MR1	1N540	28357-044
VT2	2S323	28433-318	MR2	1N540	28357-044
VT3	2N404	28423-508	MR3	1N540	28357-044
VT4	2N404	28423-508	MR4	1S44	28357-548
VT5	2N404	28423-508	MR5	ZB6.8	28371-546
VT6	2N404	28423-508	MR6	ZB6.8	28371-546
VT7	2N404	28423-508			
VT8	2N404	28423-508	PLA	3-pin, mains plug	23423-151
			R1	Met ox 24 Ω ±5% 6 W ***	24588-402
			R2	Met ox 10 kΩ ±7% 3/8 W **	24552-110
			R3	Met ox 390 Ω ±7% 3/8 W **	24552-065
XL1	Crystal QM27U	28311-690	R4	Carb 18 kΩ ±10% ¼ W ⁰	24342-116
	Socket, McMurdo X2/UB	28313-604	R5	Carb 3.3 kΩ ±10% ¼ W ⁰	24342-094

For symbols and abbreviations see introduction to this section

When ordering, prefix circuit reference with A13.

When ordering, prefix circuit reference with A13.

Circuit reference	Description	M.I. code	Circuit reference	Description	M.I. code
R6	Met ox 1.2 k Ω \pm 7% 3/8 W **	24552-082	T1	Assembly TM 7477/1	43456-004
R7	Met ox 1.6 k Ω \pm 7% 3/8 W **	24552-085			
R8	Carb 5.6 k Ω \pm 10% $\frac{1}{4}$ W ^o	24342-103	Z1	Filter, mains	23642-901
R9	Carb 10 k Ω \pm 10% $\frac{1}{4}$ W ^o	24342-110			
R10	Carb 1.2 k Ω \pm 10% $\frac{1}{4}$ W ^o	24342-082			
R11	Met ox 1.2 k Ω \pm 7% 3/8 W **	24552-082	VT1	2N1304	28443-528
R12	Met ox 750 Ω \pm 7% 3/8 W **	24552-077	VT2	2N404	28423-508
R13	Carb 10 k Ω \pm 10% $\frac{1}{2}$ W ^o	24343-110	VT3	ACY17	28426-497
R14	Met ox 2 k Ω \pm 7% 3/8 W **	24552-087	VT4	2N404	28423-508
			VT5	ACY17	28426-497
			VT6	OC25	28424-807
RV1	Carb 1 k Ω	25611-014	VT7	OC25	28424-807
RV2	WW 1 k Ω	25811-538			
				Fuse holder	23416-191
SA	Switch d. p. d. t. 110-230 V	23467-119		Locking plate for switch SA	34444-116
SB	Switch s. p. d. t. MAINS/ BATT	23467-116		Battery terminal (+)	23235-177
				Battery terminal (-)	23235-176

For symbols and abbreviations see introduction to this section

Circuit diagrams

CIRCUIT NOTES

1. ARRANGEMENT

The inter-unit wiring diagram, Fig. 7.1, shows all sub-assembly units in the equipment together with their reference designators (A1, A2 etc.) and type numbers (prefixed TM). Components that are not on a sub-assembly are part of the main chassis assembly (designated A0).

Circuit diagrams are arranged in order of the sub-assembly designations.

2. COMPONENT VALUES

Resistors : No suffix = ohms, k = kilohms, M = megohms.

Capacitors : No suffix = microfarads, p = picofarads.









Inductors : No suffix = henries, m = millihenries, μ = microhenries.

† : value selected during test, nominal value shown.

3. VOLTAGES

Printed in italics. Voltages are d. c. and relative to chassis unless otherwise indicated. Measured with a 20 k Ω /V meter.

4. SYMBOLS

	arrow indicates clockwise rotation of knob.
	preset component.
	panel marking.
	printed board tag number.
	other tag.
	printed board edge connector.
	indicates points at same supply potential.
	waveform reference number.

5. SWITCHES

Rotary switches are drawn schematically. Numbers or letters indicate control knob setting as shown in the key diagrams. Sequence of sections reading from control knob end is as follows :-

1F = 1st section, front

1B = 1st section, back

2F = 2nd section, front

etc.

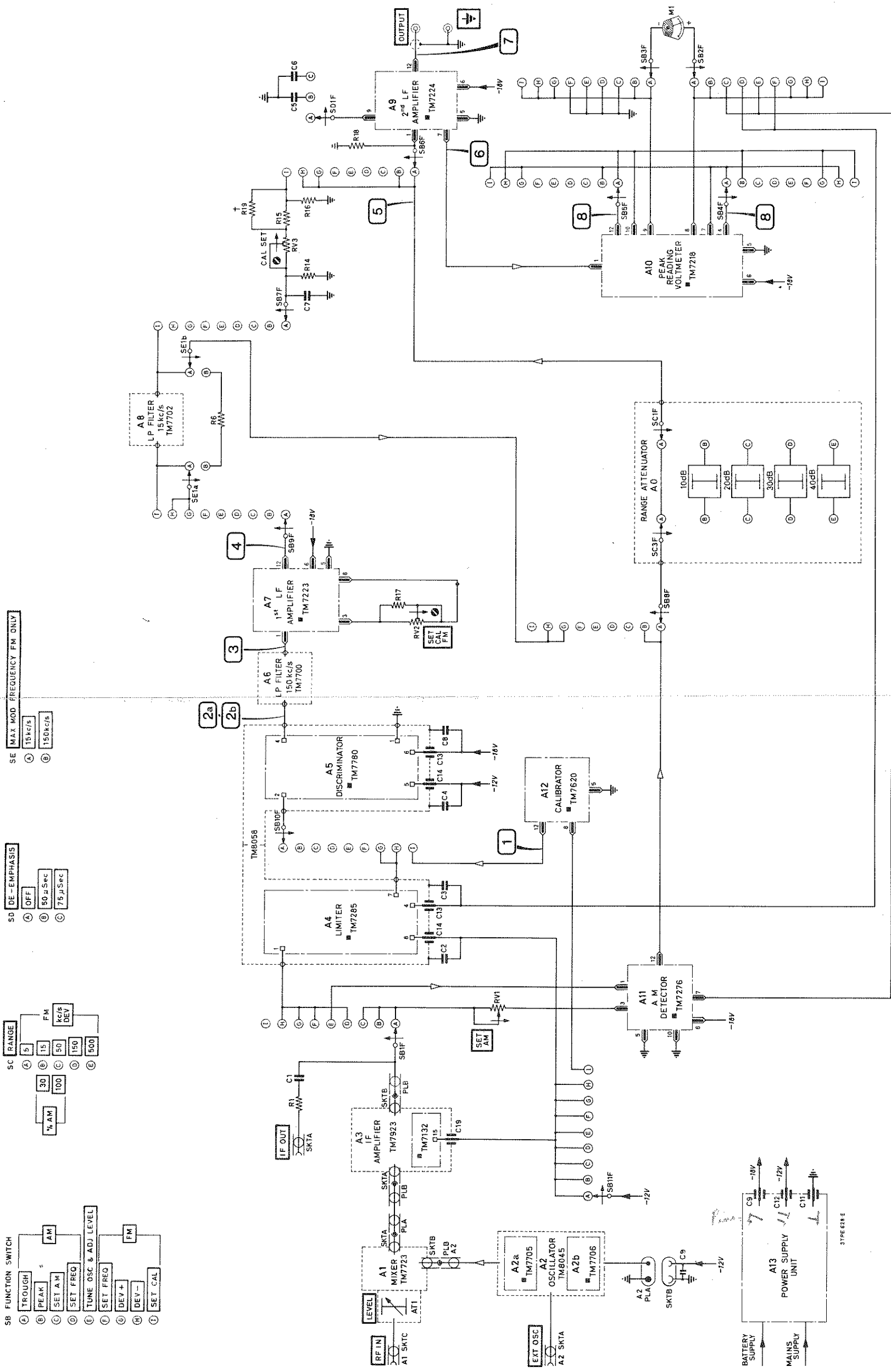

Fig. 7.1 Chassis inter-unit wiring



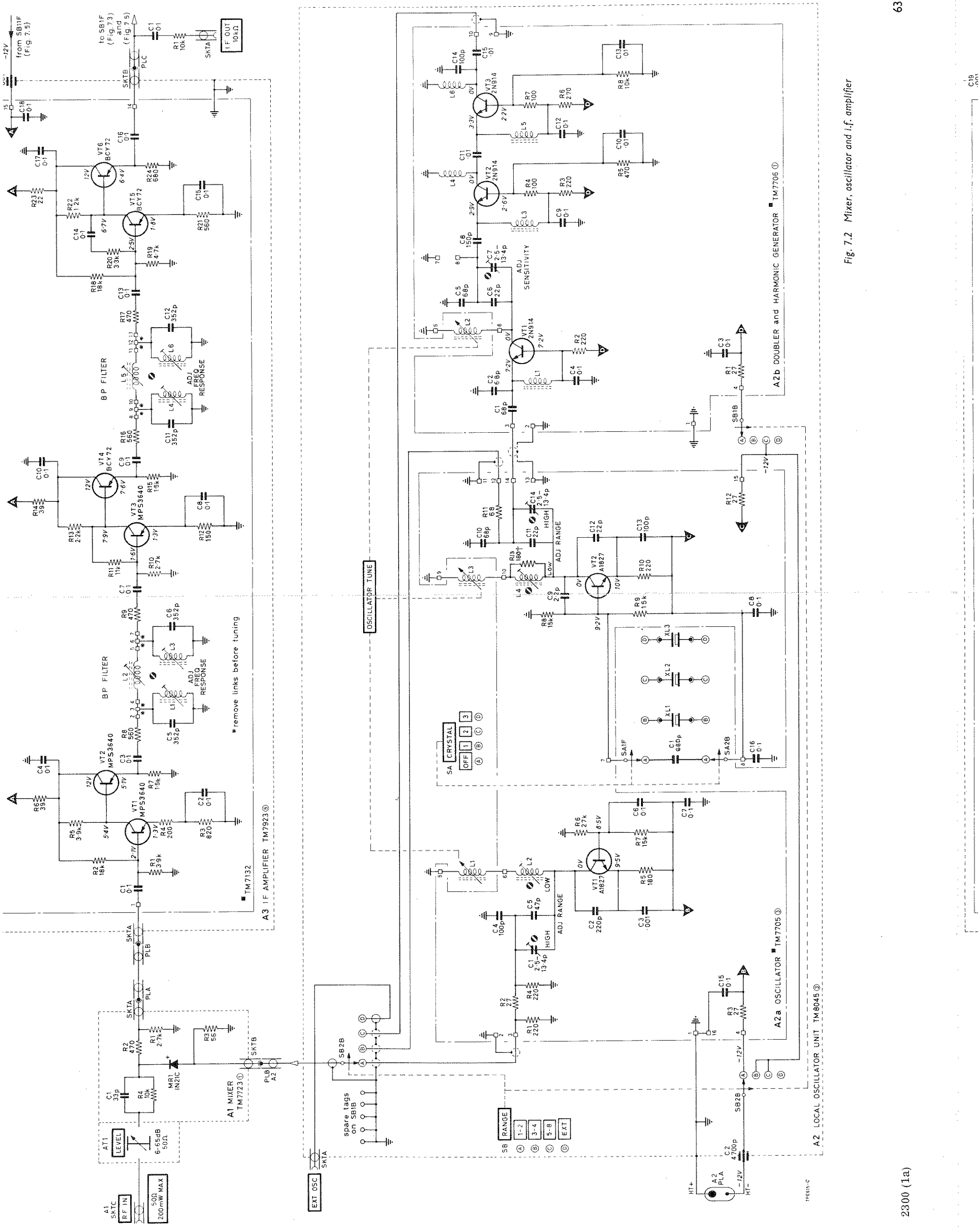

Fig. 7.2 Mixer, oscillator and i.f. amplifier

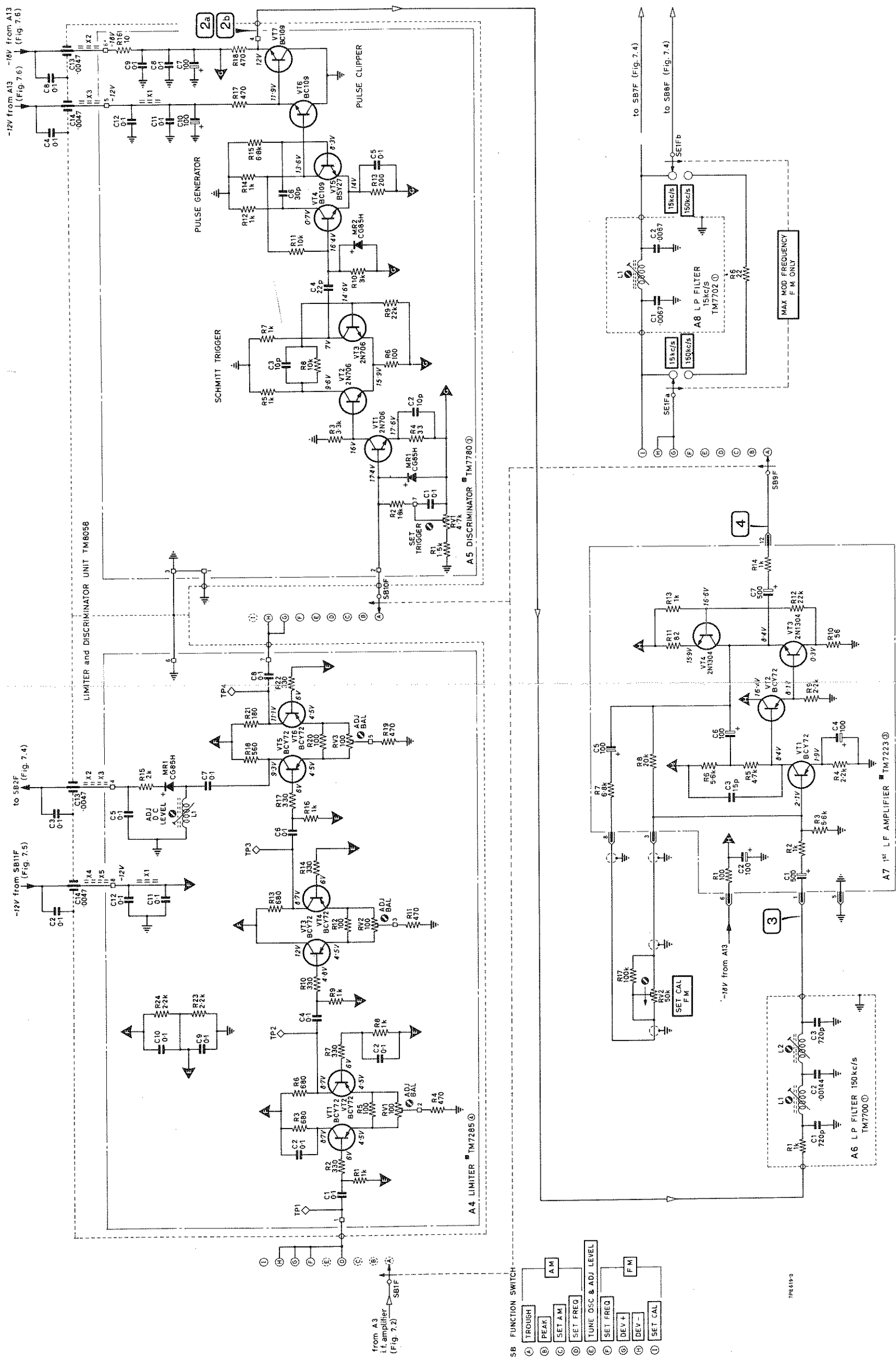

Fig. 7.3 Limiter, discriminator and 1st i.f. amplifier

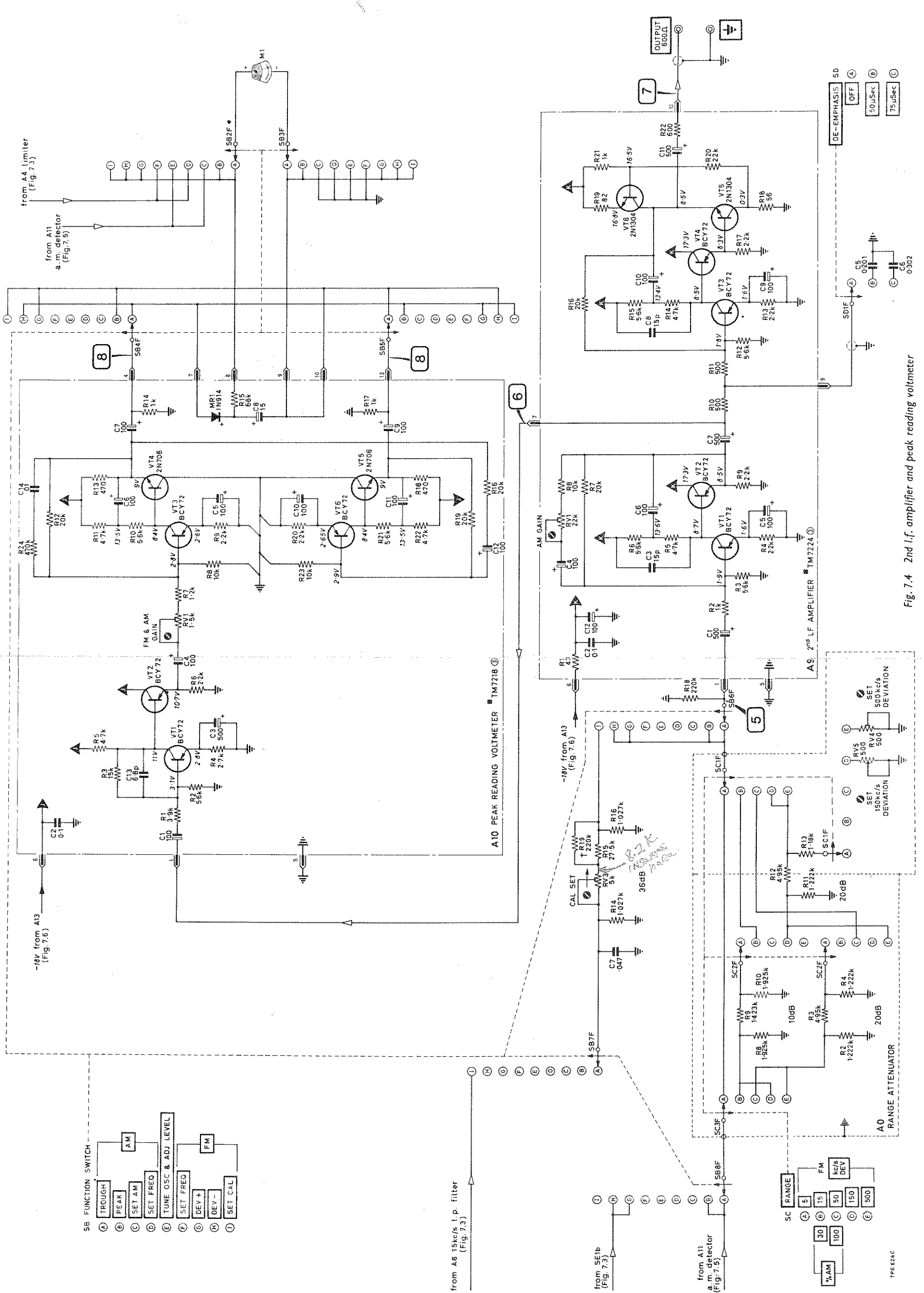

Fig. 7.4 2nd I.f. amplifier and peak reading voltmeter



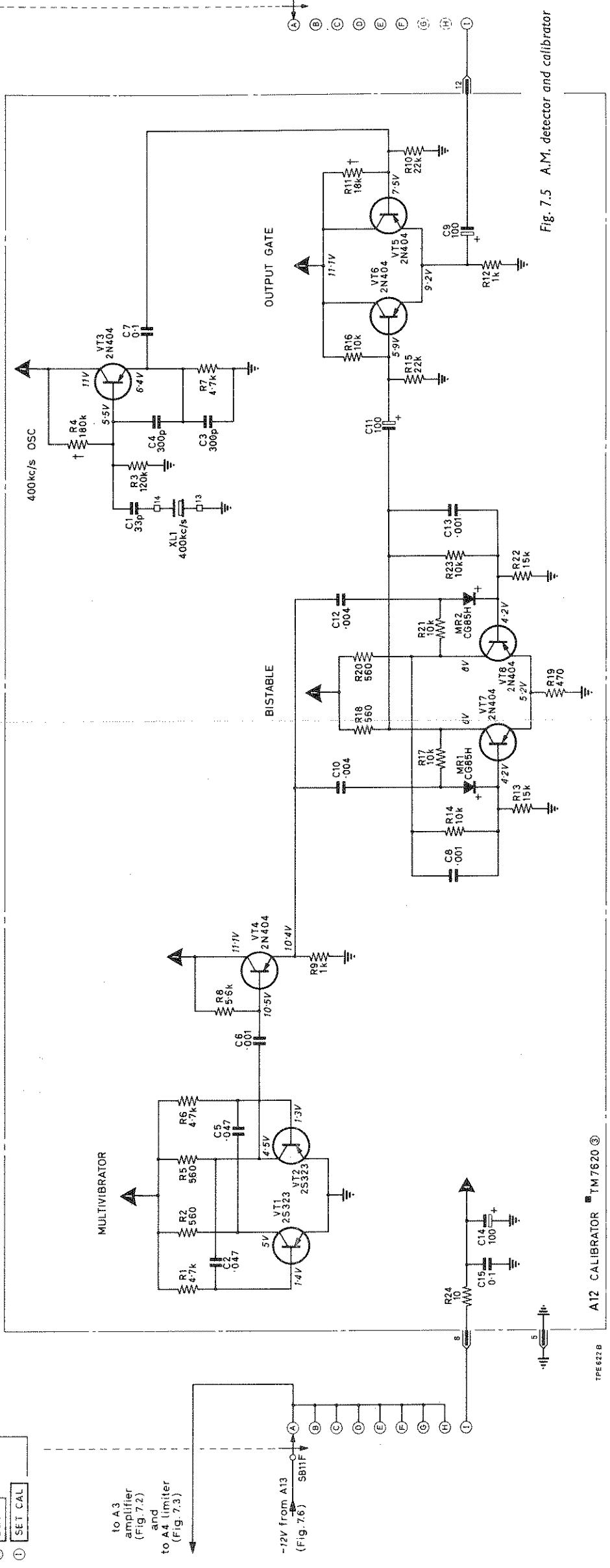
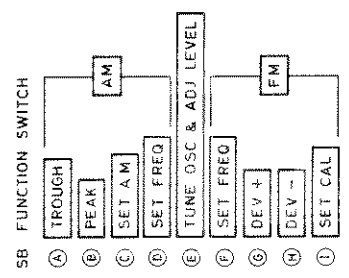
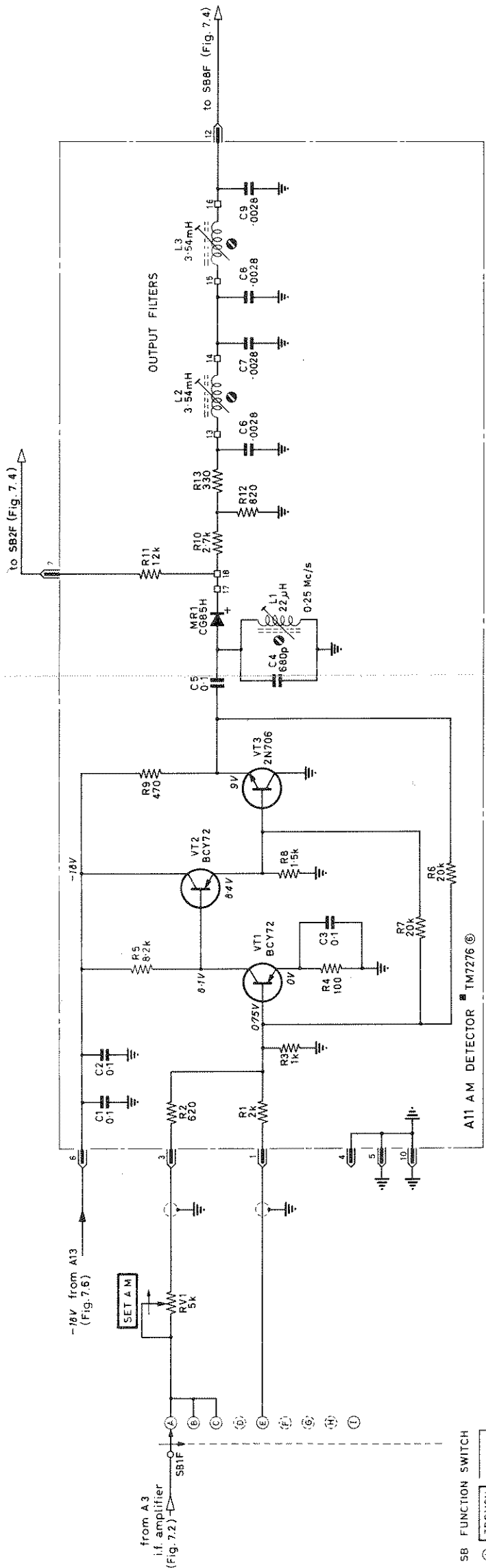

Fig. 7.5 A.M. detector and calibrator



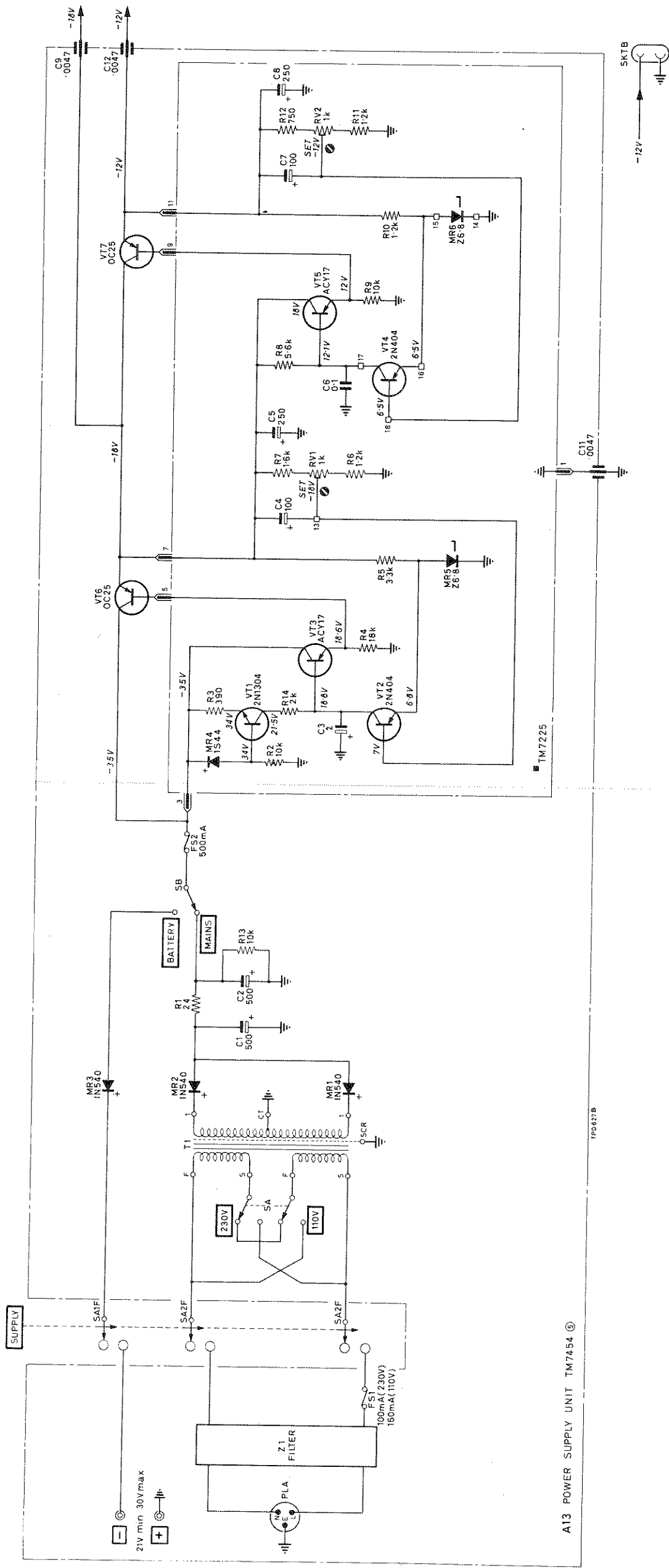

Fig. 7.6 Power supply unit



MANUAL CHANGE

for

FM/AM Modulation Meter

Type TF 2300

p. 49: The following M. I. code number has been changed on
the main assembly A0.

RV4 and RV5 should be 25815-147.

